

JVC



COMPACT COMPONENT SYSTEM SISTEMAS DE COMPONENTES COMPACTOS SISTEMA DE COMPONENTE COMPACTO 小型組合系統

نظام اجهزة صوتية مركبة

MX-J300

Consists of CA-MXJ300 and SP-MXJ300
Consta del CA-MXJ300 el SP-MXJ300
Consta do CA-MXJ300 e SP-MXJ300
由CA-MXJ300 及 SP-MXJ300組成
يتكون الجهاز مز CA-MXJ300 و SP-MXJ300

MX-J200

Consists of CA-MXJ200 and SP-MXJ200
Consta del CA-MXJ200 el SP-MXJ200
Consta do CA-MXJ200 e SP-MXJ200
由CA-MXJ200 及 SP-MXJ200組成
يتكون الجهاز مز CA-MXJ200 و SP-MXJ200

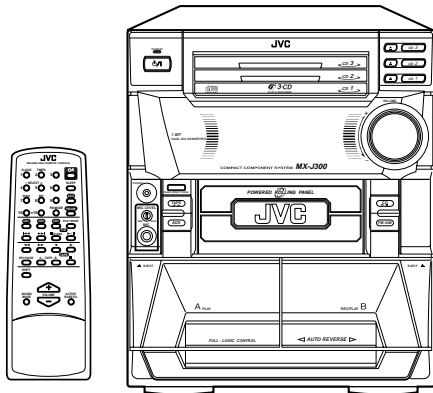

CA-MXJ300

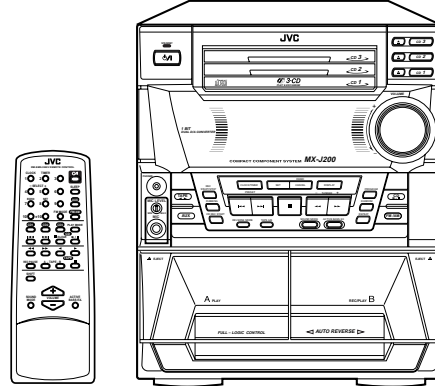

CA-MXJ200

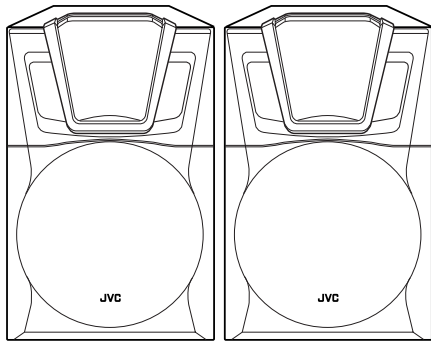

SP-MXJ300

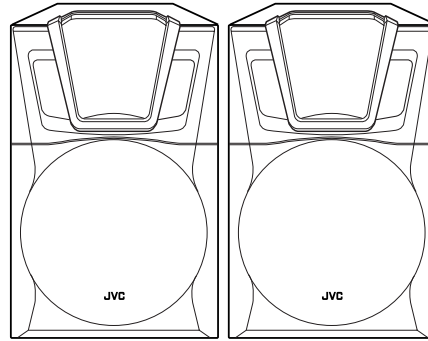

SP-MXJ200

COMPACT
disc
DIGITAL AUDIO

INSTRUCTIONS MANUAL DE INSTRUCCIONES INSTRUÇÕES 使用説明書

كتيب تعليمات التشغيل

For Customer Use:

Enter below the Model No. and Serial No. which are located either on the rear, bottom or side of the cabinet. Retain this information for future reference.

Model No. _____

Serial No. _____

LVT0484-005A
[U, US, UY, UT]

Warnings, Cautions and Others
Avisos, precauciones y otras notas
Advertências, precauções e outras notas

警告，注意及其他須知事項

تحذيرات، تنبيهات وأشياء أخرى

Caution — ⏻/⏻ switch!

Disconnect the mains plug to shut the power off completely. The ⏻/⏻ switch in any position does not disconnect the mains line. The power can be remote controlled.

注意—⏻/⏻ 開關！

無論⏻/⏻開關在任何位置，電源線的電源還是沒有被切斷，若要將電源完全關閉，應把電源插頭拔離插座。電源開關可用遙控器控制。

Precaución — Interruptor ⏻/⏻!

Desconectar el cable de alimentación para desactivar la alimentación totalmente. Cualquiera que sea la posición de ajuste del interruptor ⏻/⏻, la alimentación no es cortada completamente. La alimentación puede ser controlada remotamente.

تحذير - ⏻/⏻ الطاقة

انزع قابس الطاقة الكهربائية من اجل فصل الطاقة الكهربائية عن الجهاز كلياً. لا يفصل مفتاح الطاقة الكهربائية عندما يكون باي وضع ⏻/⏻ الطاقة الكهربائية عن الجهاز. يمكن التحكم عن بعد بالطاقة الكهربائية.

Precaução — Interruptor ⏻/⏻!

Desconectar o cabo de alimentação para desligar a alimentação por completo. Qualquer que seja a posição de ajuste do interruptor ⏻/⏻, a alimentação não é completamente cortada. A alimentação pode ser controlada remotamente.

CAUTION

To reduce the risk of electrical shocks, fire, etc.:

1. Do not remove screws, covers or cabinet.
2. Do not expose this appliance to rain or moisture.

PRECAUCIÓN

Para reducir riesgos de choques eléctricos, incendio, etc.:

1. No extraiga los tornillos, los cubiertas ni la caja.
2. No exponga este aparato a la lluvia o a la humedad.

PRECAUÇÃO

Para reduzir riscos de choques elétricos, incêndio, etc.:

1. Não remova parafusos e tampas ou desmonte a caixa.
2. Não exponha este aparelho à chuva nem à umidade.

警告

為了減低觸電，火災等危險：

1. 請勿擅自卸下螺絲釘，蓋子或機殼。
2. 切勿讓本機受雨淋或置潮濕環境中。

تحذير

لتجنب خطر الحريق، الصدمات الكهربائية، الخ.:

1. لا تقم بفك البراغي، الاغطية أو الخزانة.
2. لا تقم بتعريض هذا الجهاز للمطر أو للرطوبة.

Caution: Proper Ventilation

To avoid risk of electric shock and fire, and to prevent damage, locate the apparatus as follows:

- 1 Front: No obstructions and open spacing.
- 2 Sides/ Top/ Back: No obstructions should be placed in the areas shown by the dimensions below.
- 3 Bottom: Place on the level surface. Maintain an adequate air path for ventilation by placing on a stand with a height of 10 cm or more.

Precaución: el aparato debe estar bien ventilado

Para evitar posibles riesgos de descargas eléctricas e incendios y prevenir cualquier posible daño, coloque el aparato del modo siguiente:

- 1 Parte delantera: No ponga nada delante, deje el espacio libre.
- 2 Laterales/ parte superior/ parte trasera: No se debería colocar nada en las áreas y las distancias que se detallan a continuación.
- 3 Parte inferior: Coloque el aparato sobre una superficie recta. Debe haber buena circulación de aire; para ello, coloque el aparato sobre una base a una altura mínima de 10 cm.

Precaução: Ventilação adequada

Para evitar riscos de choques elétricos e incêndios, e prevenir avarias, instale o aparelho como segue:

- 1 Parte frontal: Sem obstruções e espaços abertos.
- 2 Partes laterais/Tampa/Posterior: Nenhuma obstrução deverá ser colocada entre as áreas cujas dimensões são indicadas abaixo.
- 3 Parte inferior: Instale-o sobre uma superfície plana. Deverá ser mantido espaço suficiente para a ventilação se este for instalado numa posição que tenha uma altura de 10 cm ou mais.

告誡：正確通風

為免發生觸電和火警的危險，及防止本機受損，請將本機如下放置：

- 1 前面：沒有障碍物及地方開闊。
- 2 側面／頂面／背面：在圖中所示範圍中，不應放置任何障礙物。
- 3 底部：放置在水平面上。放置在一個高 10 厘米或以上的臺上，以保持足夠的通風道。

تحذير: التهوية الصحيحة

لتجنب حصول صدمات كهربائية واطار الحريق ومنع حصول تلف وضرر للجهاز، ركب الجهاز كما يلي:
١ الجهة الامامية: يجب ان لا يكون هنالك عوائق ويجب ان تكون المنطقة مفتوحة امام الجهاز.
٢ الجهات الجانبية / العلوية / الخلفية: يجب عدم وضع عوائق في المناطق المبينة بالابعاد في الاسفل.
٣ القاعدة: يجب وضع الجهاز على سطح منبسط. اترك مسافة كافية من اجل التهوية بواسطة وضع الجهاز على حامل بارتفاع ١٠ سم او اكثر.

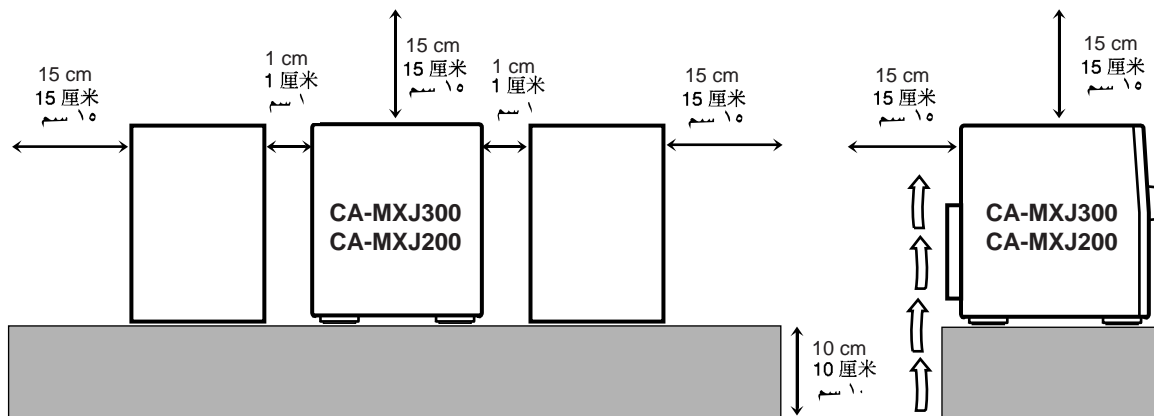

IMPORTANT FOR LASER PRODUCTS / IMPORTANTE PARA PRODUCTOS LÁSER / IMPOTANTE PARA PRODUTOS LASER / 雷射產品的重要說明 / مهم للمنتجات الليزرية

REPRODUCTION OF LABELS / REPRODUCCIÓN DE ETIQUETAS / REPRODUÇÃO DE ETIQUETAS

標籤內容說明 / إنتاج اللاصقات

- | | |
|---|---|
| ① CLASSIFICATION LABEL, PLACED ON REAR ENCLOSURE | ② WARNING LABEL, PLACED INSIDE THE UNIT |
| ① ETIQUETA DE CLASIFICACIÓN, PEGADA EN LA PARTE POSTERIOR DE LA CAJA | ② ETIQUETA DE ADVERTENCIA, PEGADA EN EL INTERIOR DE LA UNIDAD |
| ① ETIQUETA DE CLASSIFICAÇÃO LOCALIZADA NA PARTE POSTERIOR DA CAIXA DO APARELHO. | ② ETIQUETA DE ADVERTÊNCIA LOCALIZADA NA PARTE INTERNA DA UNIDADE. |
| ① 分類標籤，貼在機殼背後。 | ② 警告標籤，貼於機內。 |

① لاصق التصنيف، موضوعة على المرفق الخلفي

② لاصقة التحذير، موضوعة بداخل الجهاز

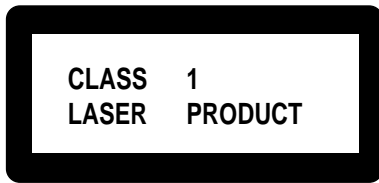

DANGER: Invisible laser radiation when open and interlock failed or defeated. AVOID DIRECT EXPOSURE TO BEAM. (e)	WARNING: Osynlig laserstrålning när denna del är öppnad och spårren är urkopplad. Betrakta ej strålen. (s)	ADVARSEL: Usynlig laserstrålning ved åbning, når sikkerhedsafbrydere er ude af funktion. Undgå udsættelse for stråling (d)	VARO: Avattaessa ja suojalukitus ohitettaessa olet alltiina näkymättömälle lasersäteilylle. Älä katso säteeseen. (f)
---	---	---	---

1. CLASS 1 LASER PRODUCT
2. **DANGER:** Invisible laser radiation when open and interlock failed or defeated. Avoid direct exposure to beam.
3. **CAUTION:** Do not open the top cover. There are no user serviceable parts inside the Unit; leave all servicing to qualified service personnel.

1. 一級雷射產品
2. 危險：當內部鎖定裝置失效或者損壞後，打開蓋板可能會產生不可見的雷射輻射。應避免受到光束直接照射。
3. 注意：請勿打開頂蓋板。本機內部沒有用戶可自行維修的部件；所有維修工作應由有資格的人員完成。

1. PRODUCTO LÁSER CLASE 1
2. **PELIGRO:** En el interior hay radiación láser invisible. Evite el contacto directo con el haz.
3. **PRECAUCIÓN:** No abra la tapa superior. En el interior de la unidad no existen piezas reparables por el usuario; deje todo servicio técnico en manos de personal calificado.

1. صنف 1 منتج ليزري
2. خطر: أشعة ليزرية غير مرئية عند الفتح والأغلاق الفاشل أو غير الصحيح. تجنب التعرض المباشر للأشعة.
3. تحذير: لا تفتح الغطاء العلوي، ليس في داخل الجهاز أقسام بمستطاع المستخدم صيانتها؛ إعهد بكافة الأعمال الصيانة لفني مختص.

1. PRODUTO LASER CLASSE 1
2. **PERIGO:** O laser emite uma radiação invisível que é perigosa, caso o aparelho esteja aberto e a trava inoperante ou danificada. Evite exposição direta ao feixe dos raios.
3. **CUIDADO:** Não abra a caixa do aparelho. Não existem peças reparáveis pelo usuário na parte interna da unidade. Solicite assistência técnica somente a pessoal técnico qualificado.

Introduction

We would like to thank you for purchasing one of our JVC products. Before operating this unit, read this manual carefully and thoroughly to obtain the best possible performance from your unit, and retain this manual for future reference.

About This Manual

This manual is organized as follows:

- The manual mainly explains operations using the buttons and controls on the unit. You can also use the buttons on the remote control if they have the same or similar names (or marks) as those on the unit. If operation using the remote control is different from that using the unit, it is then explained.
- The illustrations used in this manual are of CA-MXJ300.
- Basic and common information that is the same for many functions is grouped in one place, and is not repeated in each procedure. For instance, we do not repeat the information about turning on/off the unit, setting the volume, changing the sound effects, and others, which are explained in the section "Common Operations" on pages 11 to 13.
- The following marks are used in this manual:



Gives you warnings and cautions to prevent from a damage or risk of fire/electric shock. Also gives you information which is not good for obtaining the best possible performance from the unit.



Gives you information and hints you had better know.

Precautions

Installation

- Install in a place which is level, dry and neither too hot nor too cold — between 5°C (41°F) and 35°C (95°F).
- Install the unit in a location with adequate ventilation to prevent internal heat built-up in the unit.
- Leave sufficient distance between the unit and the TV.
- Keep the speakers away from the TV to avoid interference with TV.



DO NOT install the unit in a location near heat sources, or in a place subject to direct sunlight, excessive dust or vibration.

Power sources

- When unplugging from the wall outlet, always pull the plug, not the AC power cord.



DO NOT handle the AC power cord with wet hands.

Moisture condensation

Moisture may condense on the lens inside the unit in the following cases:

- After starting heating in the room
 - In a damp room
 - If the unit is brought directly from a cold to a warm place
- Should this occur, the unit may malfunction. In this case, leave the unit turned on for a few hours until the moisture evaporates, unplug the AC power cord, and then plug it in again.

Others

- Should any metallic object or liquid fall into the unit, unplug the unit and consult your dealer before operating any further.
- If you are not going to operate the unit for an extended period of time, unplug the AC power cord from the wall outlet.



DO NOT disassemble the unit since there are no user serviceable parts inside.

If anything goes wrong, unplug the AC power cord and consult your dealer.

Location of the Buttons and Controls	3
CA-MXJ300 Front Panel	4
CA-MXJ200 Front Panel	6
Remote Control	7
Getting Started	8
Unpacking	8
Putting the Batteries into the Remote Control	8
Connecting Antennas	8
Connecting Speakers	9
Connecting Other Equipment	10
Adjusting the Voltage Selector	10
Common Operations	11
Setting the Clock	11
Turning On the Power and Selecting the Sources	12
Setting the AM Tuner Interval Spacing	12
Adjusting the Volume	12
Reinforcing the Bass Sound	13
Selecting the Sound Modes	13
Listening to FM and AM Broadcasts	14
Tuning in a Station	14
Presetting Stations	14
Tuning in a Preset Station	14
Playing Back CDs	15
Loading CDs	15
Playing Back the Entire Discs	
— Continuous Play	15
Basic CD Operations	15
Programming the Playing Order of the Tracks	
— Program Play	16
Playing at Random — Random Play	17
Repeating Tracks or CDs — Repeat Play	18
Prohibiting Disc Ejection — Tray Lock	18
Playing Back Tapes	19
Playing Back a Tape	19
Recording	20
Recording Tapes on Deck B	20
Dubbing Tapes	21
CD Direct Recording	21
Using the Microphone	22
Singing Along	22
Using the Timers	23
Using Daily Timer	23
Using Recording Timer	25
Using Sleep Timer	27
Timer Priority	27
Maintenance	28
Troubleshooting	29
Specifications	30

Location of the Buttons and Controls

CA-MXJ300

Become familiar with the buttons and controls on your unit.

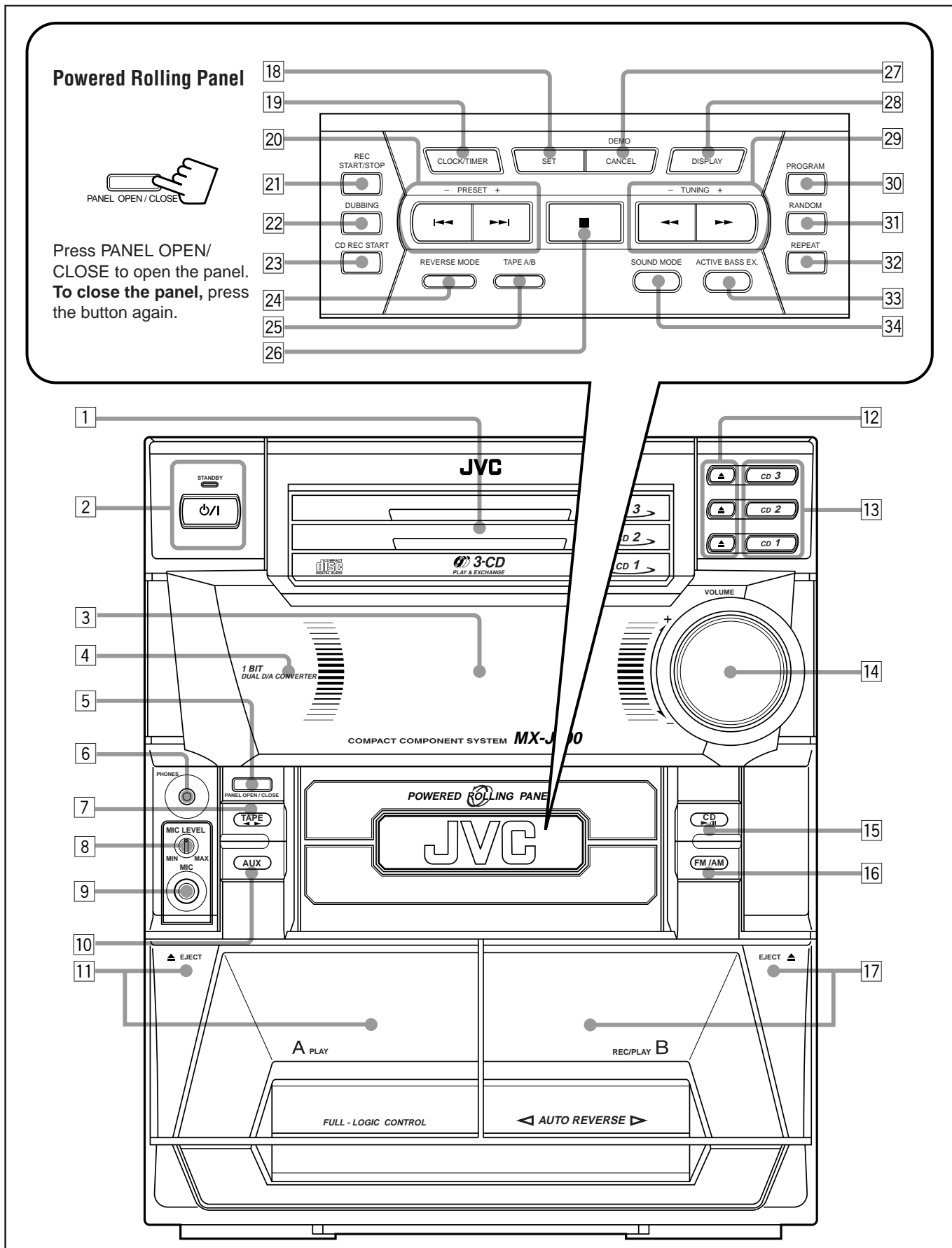

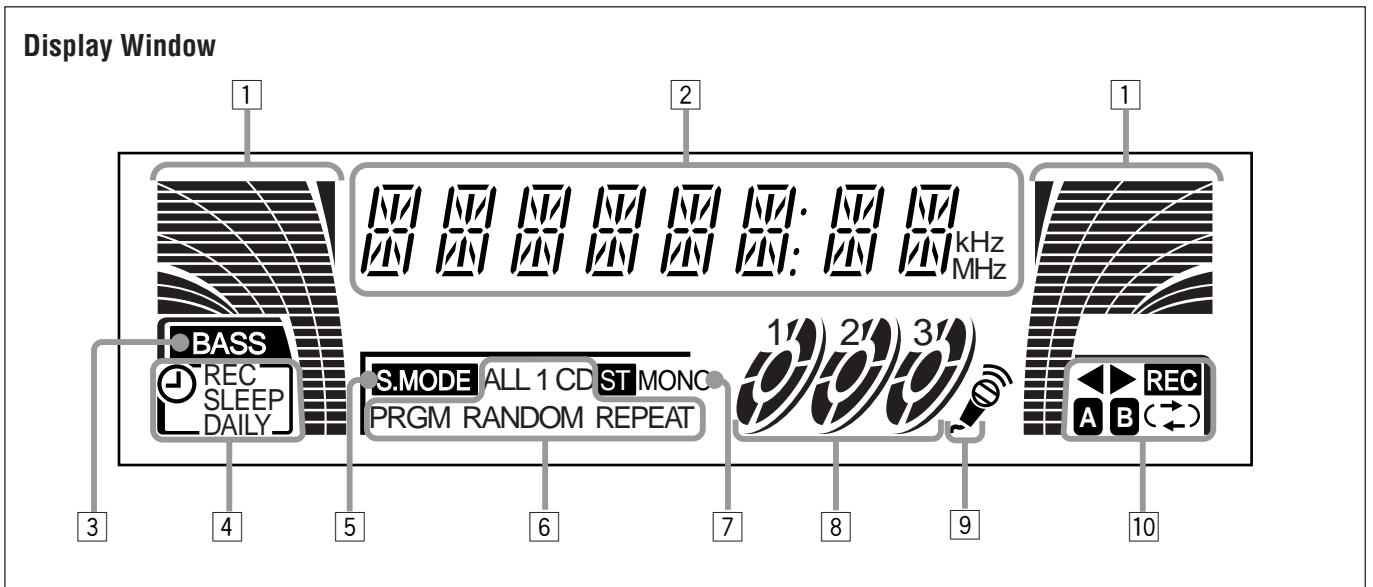

See pages in the parentheses for details.

CA-MXJ300 Front Panel

- 1 Disc trays
- 2 \odot/I (standby/on) button and STANDBY lamp (12)
- 3 Display window
- 4 Remote sensor
- 5 PANEL OPEN/CLOSE button (11)
Pressing this button also turns on the unit.
- 6 PHONES jack (12)
- 7 TAPE $\blacktriangleleft/\blacktriangleright$ button and lamp (19)
Pressing this button also turns on the unit.
- 8 MIC LEVEL control (22)
- 9 MIC jack (22)
- 10 AUX button and lamp (12)
Pressing this button also turns on the unit.
- 11 Deck A cassette holder (19)
 - Pressing the \blacktriangle EJECT portion open the holder.
- 12 \blacktriangle (CD tray open/close) buttons (15)
Pressing one of these buttons also turns on the unit.
- 13 Disc number buttons (CD 1, CD 2, and CD 3) (15, 21)
Pressing one of these buttons also turns on the unit.
- 14 VOLUME control (12)
- 15 CD $\blacktriangleright/\text{II}$ (play/pause) button and lamp (15)
Pressing this button also turns on the unit.
- 16 FM/AM button and lamp (14)
Pressing this button also turns on the unit.
- 17 Deck B cassette holder (19)
 - Pressing the EJECT \blacktriangle portion open the holder.

Powered Rolling Panel

- 18 SET button (11, 23)
- 19 CLOCK/TIMER button (11, 23)
- 20 PRESET $-/+$ buttons (14)
 $\blacktriangleleft/\blacktriangleright$ (reverse search/forward search) buttons (11, 16, 23)
 $\blacktriangleleft/\blacktriangleright$ (fast left/fast right) buttons (19)

- 21 REC START/STOP button (20)
- 22 DUBBING button (21)
- 23 CD REC START button (21)
- 24 REVERSE MODE button (19, 21)
- 25 TAPE A/B button (19)
- 26 \blacksquare (stop) button (15, 19)
- 27 CANCEL button (11, 17, 23)
DEMO button (10)
- 28 DISPLAY button (11)
- 29 TUNING $-/+$ buttons (14)
These buttons do not function as $\blacktriangleleft/\blacktriangleright$.
- 30 PROGRAM button (16, 21)
- 31 RANDOM button (17)
- 32 REPEAT button (18)
- 33 ACTIVE BASS EX. (extension) button (13)
- 34 SOUND MODE button (13)

Display window

- 1 Audio level indicator
- 2 Main display
 - Shows the source name, frequency, etc.
- 3 BASS (active bass extension) indicator
- 4 Timer indicators
 - \odot , REC, SLEEP, and DAILY indicators
- 5 S.MODE indicator
- 6 CD play mode indicators
 - PRGM (program), RANDOM and REPEAT (ALL/1CD/1) indicators
- 7 Tuner operation indicators
 - ST (stereo) and MONO indicators
- 8 Disc indicators
- 9 Karaoke (K) and echo (E) indicators
- 10 Tape operation indicators
 - $\blacktriangleleft/\blacktriangleright$ (tape direction), REC, A/B (operating deck) and C (reverse mode) indicators

CA-MXJ200

Become familiar with the buttons and controls on your unit.

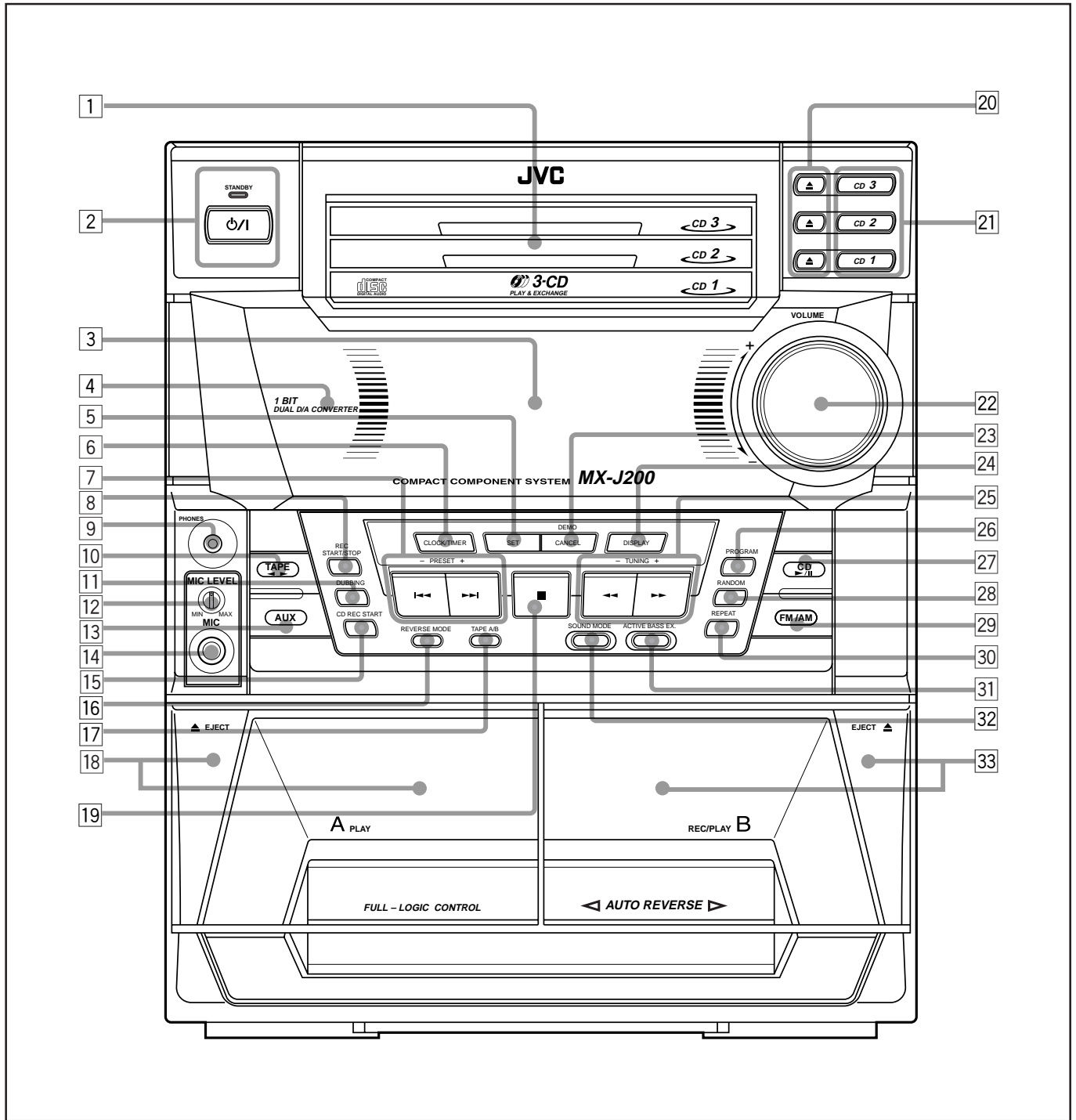

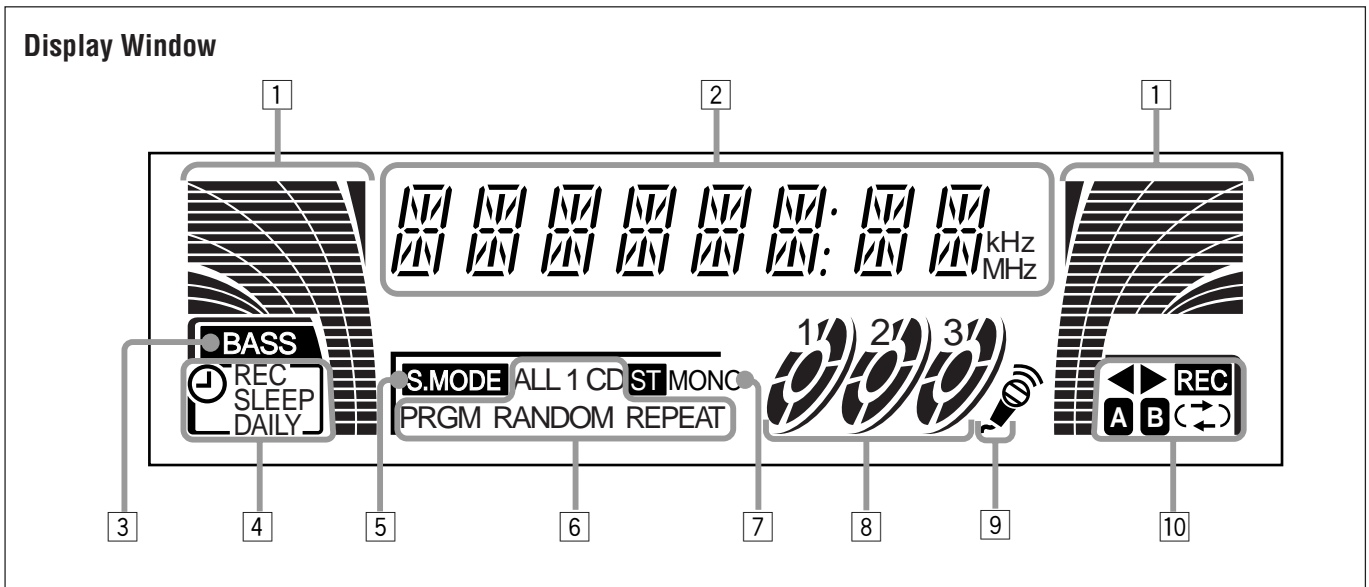

See pages in the parentheses for details.

CA-MXJ200 Front Panel

- 1 Disc trays
- 2 (standby/on) button and STANDBY lamp (12)
- 3 Display window
- 4 Remote sensor
- 5 SET button (11, 23)
- 6 CLOCK/TIMER button (11, 23)
- 7 PRESET - / + buttons (14)
 / (reverse search/forward search) buttons (11, 16, 23)
 / (fast left/fast right) buttons (19)
- 8 REC START/STOP button (20)
- 9 PHONES jack (12)
- 10 TAPE button and lamp (19)
Pressing this button also turns on the unit.
- 11 DUBBING button (21)
- 12 MIC LEVEL control (22)
- 13 AUX button and lamp (12)
Pressing this button also turns on the unit.
- 14 MIC jack (22)
- 15 CD REC START button (21)
- 16 REVERSE MODE button (19, 21)
- 17 TAPE A/B button (19)
- 18 Deck A cassette holder (19)
 - Pressing the EJECT portion open the holder.
- 19 (stop) button (15, 19)
- 20 (CD tray open/close) buttons (15)
Pressing one of these buttons also turns on the unit.
- 21 Disc number buttons (CD 1, CD 2, and CD 3) (15, 21)
Pressing one of these buttons also turns on the unit.
- 22 VOLUME control (12)

- 23 CANCEL button (11, 17, 23)
 DEMO button (10)
- 24 DISPLAY button (11)
- 25 TUNING - / + buttons (14)
These buttons do not function as / .
- 26 PROGRAM button (16, 21)
- 27 CD (play/pause) button and lamp (15)
Pressing this button also turns on the unit.
- 28 RANDOM button (17)
- 29 FM/AM button and lamp (14)
Pressing this button also turns on the unit.
- 30 REPEAT button (18)
- 31 ACTIVE BASS EX. (extension) button (13)
- 32 SOUND MODE button (13)
- 33 Deck B cassette holder (19)
 - Pressing the EJECT portion open the holder.

Display window

- 1 Audio level indicator
- 2 Main display
 - Shows the source name, frequency, etc.
- 3 BASS (active bass extension) indicator
- 4 Timer indicators
 - , REC, SLEEP, and DAILY indicators
- 5 S.MODE indicator
- 6 CD play mode indicators
 - PRGM (program), RANDOM and REPEAT (ALL/1CD/1) indicators
- 7 Tuner operation indicators
 - ST (stereo) and MONO indicators
- 8 Disc indicators
- 9 Karaoke () and echo () indicators
- 10 Tape operation indicators
 - (tape direction), REC, A/B (operating deck) and (reverse mode) indicators

Remote Control

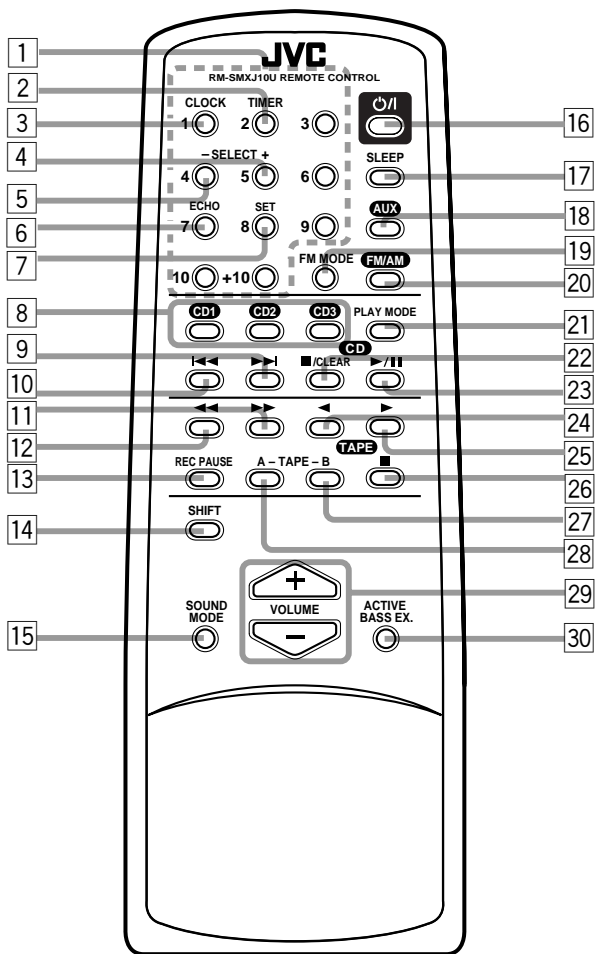

Remote Control

- 1 Number buttons (14, 16)
- 2 TIMER button (23, 25)
- 3 CLOCK button (11)
- 4 SELECT + button (11, 23, 25)
- 5 SELECT - button (11, 23, 25)
- 6 SET button (11, 23, 25)
- 7 ECHO button (22)
- 8 Disc number buttons (CD 1, CD 2, and CD 3) (15, 21)
Pressing one of these buttons also turns on the unit.
- 9 ►► (forward search) button (11, 16, 23)
- 10 ◀◀ (reverse search) button (11, 16, 23)
- 11 ►► (fast right) button (19)
- 12 ◀◀ (fast left) button (19)
- 13 REC PAUSE button (20)
- 14 SHIFT button (11, 22, 23, 25)
- 15 SOUND MODE button (13)
- 16 ◻/I (standby/on) button (12)
- 17 SLEEP button (26)
- 18 AUX button (12)
Pressing this button also turns on the unit.
- 19 FM MODE button (14)
- 20 FM/AM button (14)
Pressing this button also turns on the unit.
- 21 PLAY MODE button (16, 17)
- 22 CD ◼ (stop) button (15)
CLEAR button (17)
- 23 CD ►/|| button (15)
Pressing this button also turns on the unit.
- 24 TAPE ◀ button (20)
Pressing this button also turns on the unit.
- 25 TAPE ► button (20)
Pressing this button also turns on the unit.
- 26 TAPE ◼ (stop) button (19)
- 27 TAPE B button (19)
- 28 TAPE A button (19)
- 29 VOLUME + / - buttons (12)
- 30 ACTIVE BASS EX. (extension) button (13)

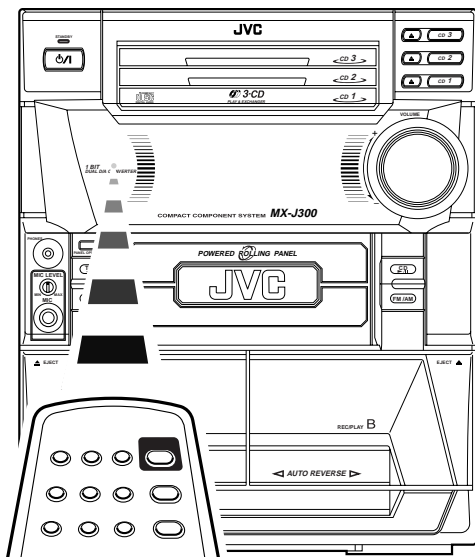

When using the remote control, point it at the remote sensor on the front panel.

Unpacking

After unpacking, check to be sure that you have all the following items.
The number in the parentheses indicates the quantity of the pieces supplied.

- AM loop antenna (1)
- FM antenna (1)
- Remote control (1)
- Batteries (2)
- AC plug adaptor (except for Argentina: 1)

If any is missing, consult your dealer immediately.

Putting the Batteries into the Remote Control

Insert the batteries — R6P/R6PU(SUM-3)/AA(15F) — into the remote control, by matching the polarity (+ and -) on the batteries with the + and - markings on the battery compartment.

When the remote control can no longer operate the unit, replace both batteries at the same time.

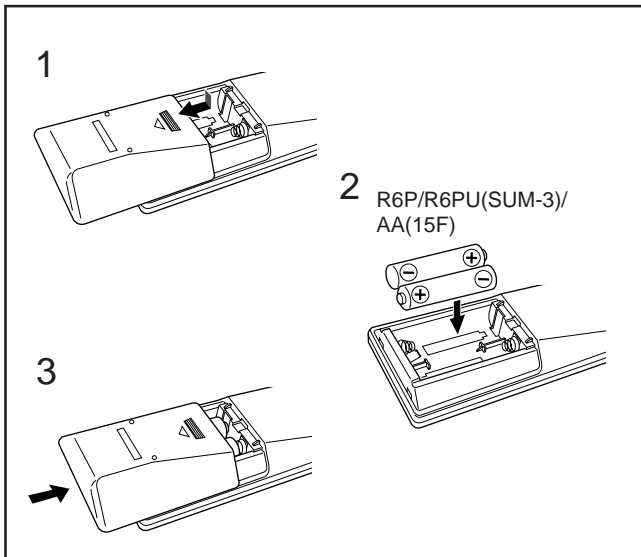

- DO NOT use an old battery together with a new one.
- DO NOT use different types of batteries together.
- DO NOT expose batteries to heat or flame.
- DO NOT leave the batteries in the battery compartment when you are not going to use the remote control for an extended period of time. Otherwise, it will be damaged from battery leakage.

Connecting Antennas

FM antenna

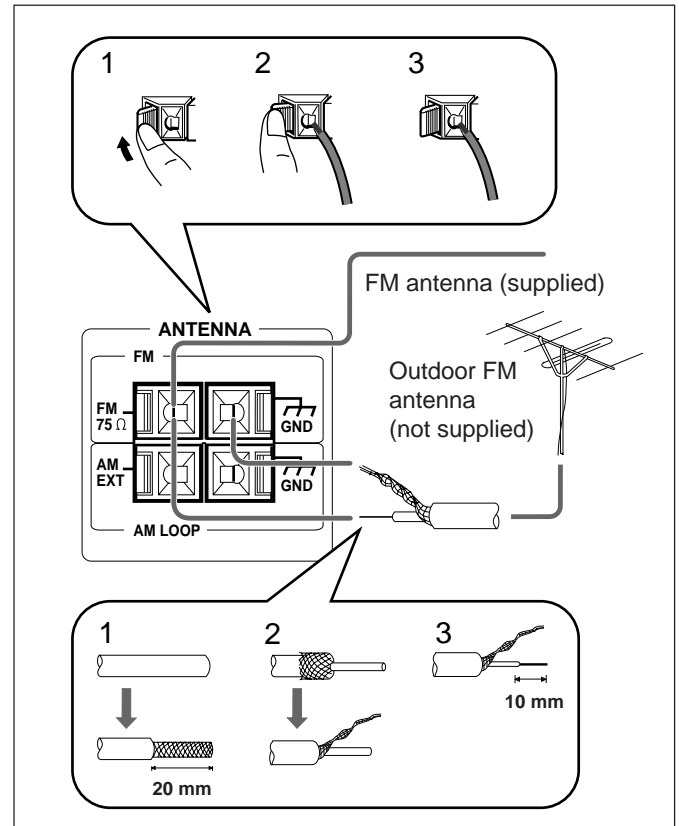

Extend the FM antenna (supplied) horizontally.



If reception is poor

Connect the outdoor antenna.
Before attaching a 75 Ω coaxial cable (the kind with a round wire going to an outdoor antenna), disconnect the supplied FM antenna.

How to strip the 75 Ω coaxial cable and connect it to the FM terminals

- 1.Strip off the outside covering of the 75 Ω coaxial cable to expose the braided metallic mesh about 20 mm (13/16 inches).
- 2.Pull the mesh back and twist it into a single connector as shown in the illustration above.
- 3.Strip the insulation about 10 mm (7/16 inches) back from the central wire.
- 4.Insert the twisted mesh and the central wire to the FM terminals, as shown in the illustration above.

AM antenna

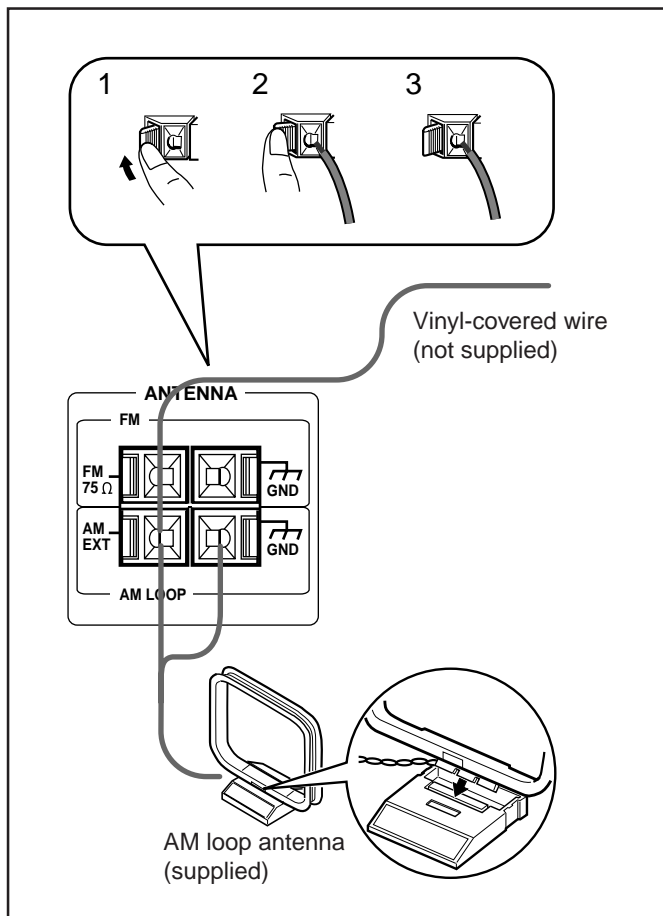

- 1 **Connect the AM loop antenna to the AM LOOP terminals as illustrated.**
- 2 **Turn the AM loop antenna until you have the best reception.**

To connect an outdoor AM antenna

When reception is poor, connect a single vinyl-covered wire to the AM EXT terminal and extend it horizontally. (The AM loop antenna must remain connected.)



For better reception of both FM and AM

- Make sure the antenna conductors do not touch any other terminals and connecting cords.
- Keep the antennas away from metallic parts of the unit, connecting cords, and the AC power cord.

Connecting Speakers

You can connect a pair of the front speakers.

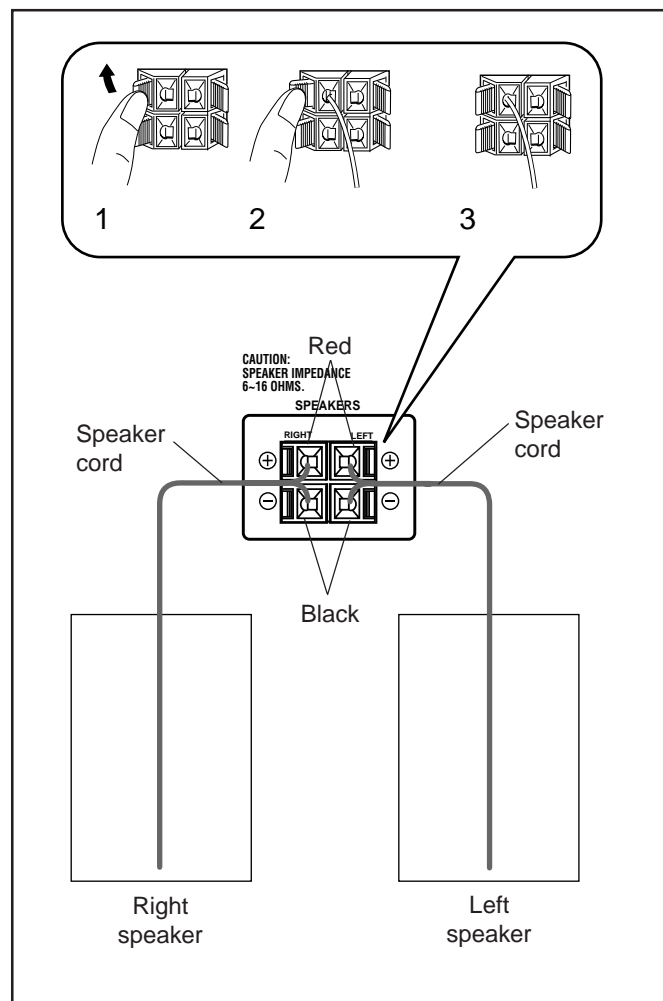

- 1 **Press and hold the clamp of the speaker terminal on the rear of the unit.**
- 2 **Insert the end of the speaker cord into the terminal.**
Match the polarity of the speaker terminals: Red (+) to red (+) and black (-) to black (-).
- 3 **Release the finger from the clamp.**

IMPORTANT: Use only speakers with the same speaker impedance as indicated by the speaker terminals on the rear of the unit.

Connecting Other Equipment

You can connect an audio equipment — used only as a playback device.

When you connect and use this equipment, refer also to its manual.

Be sure that the plugs of the audio cords are color coded: White plugs and jacks are for left audio signals, and red ones for right audio signals.



- DO NOT connect any equipment while the power is on.
- DO NOT plug in any equipment until all connections are complete.

To connect audio equipment

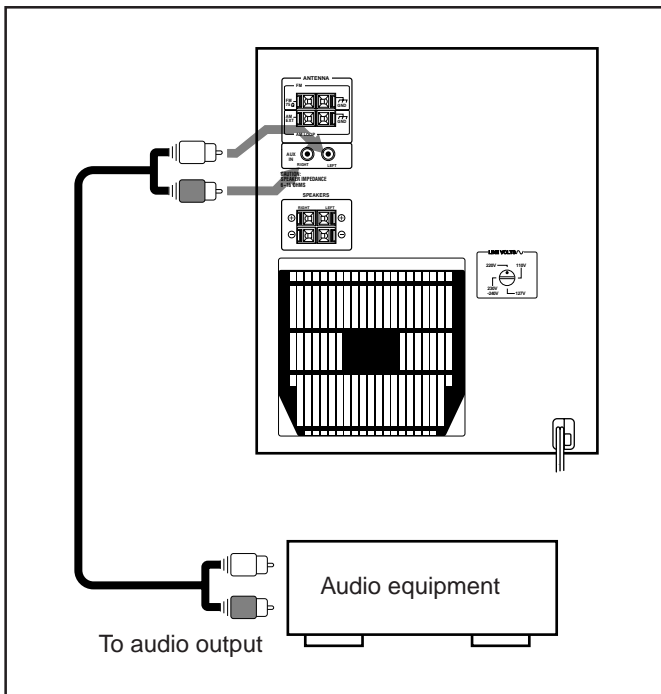

Connect the audio output jacks on the other equipment and the AUX IN jacks on the rear, using an audio cord (not supplied).

Adjusting the Voltage Selector

Before plugging in the unit, set the correct voltage for your area with the voltage selector on the rear of the unit.



- DO NOT plug in before setting the voltage selector on the rear of the unit and all connection procedures are complete.

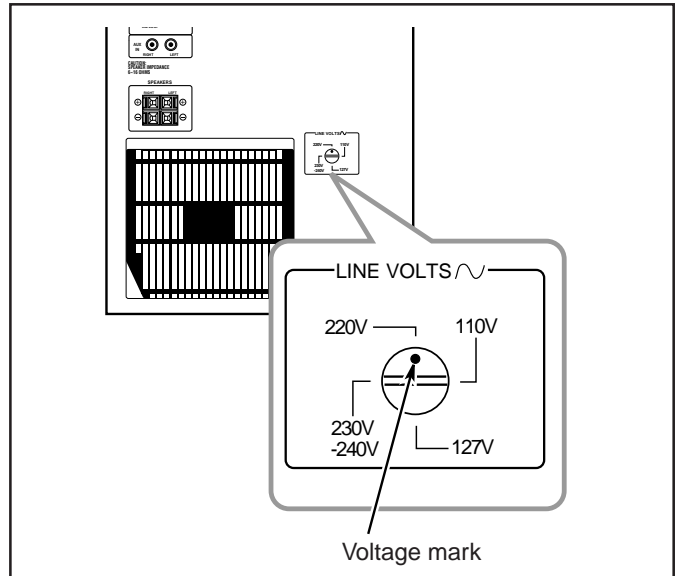

Use a screwdriver to rotate the voltage selector so the voltage number the voltage mark is pointing at is the same as the voltage where you are plugging in the unit.

NOW, you can plug in the unit and other connected equipment FINALLY!

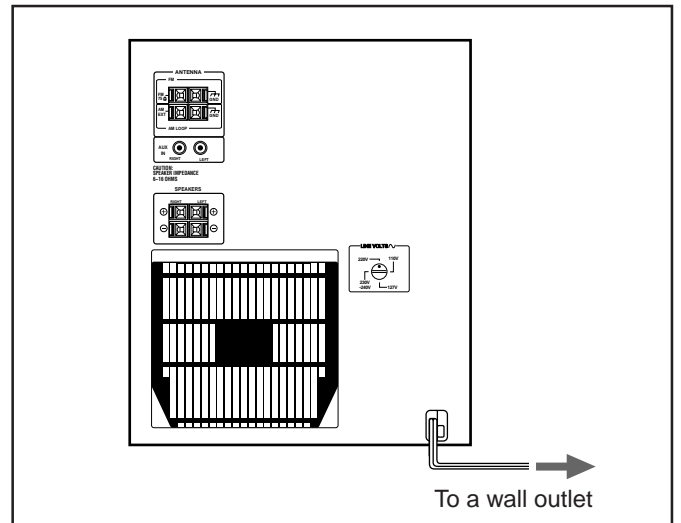

When connecting the AC power cord into a wall outlet, the unit automatically starts display demonstration.

To stop the display demonstration, press any button which turns on the unit. (Refer to pages 4 and 6 for details.)

To start the display demonstration manually
Press and hold **DEMO** for more than 2 seconds.

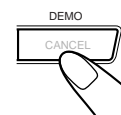

To stop the demonstration, press any button which turns on the unit. (Refer to pages 4 and 6 for details.)

Common Operations

Setting the Clock

Before operating the unit any further, first set the clock built in this unit.

For CA-MXJ300 only

Press PANEL OPEN/CLOSE.

The unit is turned on and the Powered Rolling Panel opens automatically.



On the unit:

1 Press CLOCK/TIMER.



The hour digits start flashing on the display.

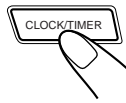

2 Press ◀◀ or ▶▶ to adjust the hour, then press SET.

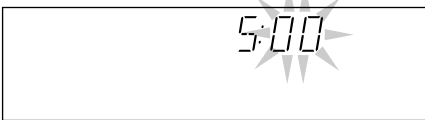

- If you want to correct the hour after pressing SET, press CANCEL. The hour digits start flashing again.

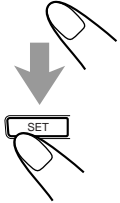

3 Press ◀◀ or ▶▶ to adjust the minute, then press SET.

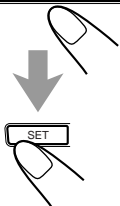
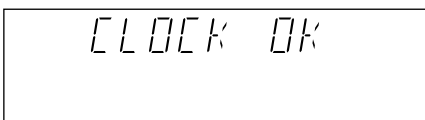

On the remote control:

1 Press SHIFT.



2 Press CLOCK.

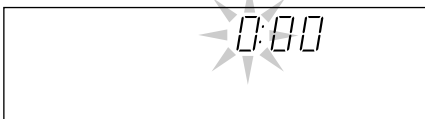

The hour digits start flashing on the display.

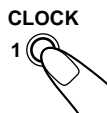

3 Press SELECT – or + to adjust the hour, then press SET.



- If you want to correct the hour after pressing SET, press CANCEL (on the unit). The hour digits start flashing again.

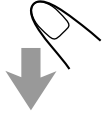

4 Press SELECT – or + to adjust the minute, then press SET.



To check the clock time

Press DISPLAY while playing any source.

- Each time you press the button, the source indication and the clock time alternate on the display.

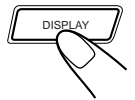

To adjust the clock again

If you have adjusted the clock before, you need to press CLOCK/TIMER repeatedly until the clock setting mode is selected.

- Each time you press the button, the clock/timer setting modes change as follows:

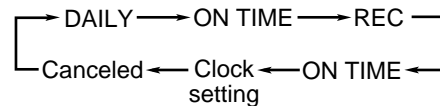

(The hour digits start flashing.)



notes If there is a power failure

The clock loses the setting and is reset to “0:00.” You need to set the clock again.

Turning On the Power and Selecting the Sources

When you press the play button for a particular source (FM/AM, CD ▶/■, TAPE ◀▶, and AUX), the unit turns on. (For CA-MXJ300 only, the Powered Rolling Panel opens automatically.)

The unit starts playing the source if it is ready — COMPU PLAY CONTROL.

To listen to the FM/AM broadcasts, press FM/AM. (See page 14.)

To play back CDs, press CD ▶/■. (See pages 15 – 18.)

To play back tapes, press TAPE ◀▶. (See page 19.)

To select the external equipment as the source, press AUX.

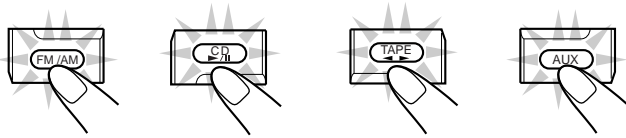

To turn on the unit without playing, press (standby/on) so that the STANDBY lamp goes off.

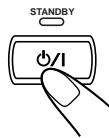

(For CA-MXJ300 only, the Powered Rolling Panel opens automatically.)

To turn off the unit (on standby), press (standby/on) again so that the STANDBY lamp lights up.

(For CA-MXJ300 only, the Powered Rolling Panel also closes.)

A little power is always consumed even while the unit is on standby.

To switch off the power supply completely, unplug the AC power cord from the AC outlet.



When you unplug the AC power cord or if a power failure occurs

The clock is reset to “0:00” right away, while the tuner preset stations (see page 14) will be erased in a few days.

Setting the AM Tuner Interval Spacing

Some countries space AM stations 9 kHz apart, and some countries use 10 kHz spacing.

On the unit ONLY:

You can only change the AM tuner interval spacing while tuning into an AM station.

Press FM/AM while holding down .

- Each time you press the button, the AM tuner interval spacing alternates between 9 kHz and 10 kHz.



Adjusting the Volume

You can adjust the volume level only while the unit is turned on.

Turn VOLUME clockwise to increase the volume or counterclockwise to decrease it.

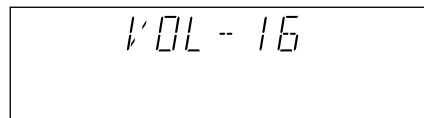
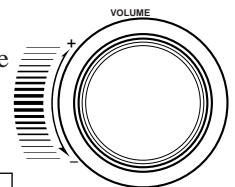

When using the remote control, press VOLUME + to increase the volume or press VOLUME – to decrease it.



For private listening

Connect a pair of headphones to the PHONES jack. No sound comes out of the speakers. Be sure to turn down the volume before connecting or putting on headphones.



DO NOT turn off (on standby) the unit with the volume set to an extremely high level; otherwise, a sudden blast of sound can damage your hearing, speakers and/or headphones when you turn on the unit or start playing any source next time. REMEMBER you cannot adjust the volume level while the unit is on standby.

Reinforcing the Bass Sound

The richness and fullness of the bass sound is maintained regardless of how low you set the volume. You can use this effect only for playback.

To get the effect, press ACTIVE BASS EX.



ACTIVE BASE EX.



The BASS indicator lights up on the display.

To cancel the effect, press the button again.

Selecting the Sound Modes

You can select one of the 6 preset sound modes (3 surround modes and 3 SEA – Sound Effect Amplifier – modes) and Vocal Masking*. The sound modes can be applied only to playback sounds, and cannot be used for recording.

* For Vocal Masking, see page 22.

To select the sound modes, press SOUND MODE until the sound mode you want appears on the display.

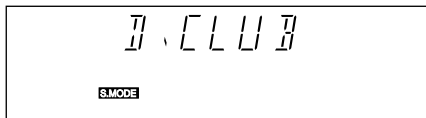

SOUND MODE



The S.MODE indicator also lights up on the display.

- Each time you press the button, the sound modes change as follows:

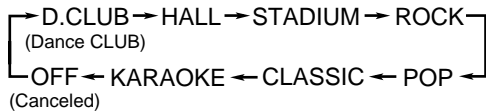

Surround modes:

- D.CLUB:** Increases resonance and bass.
HALL: Adds depth and brilliance to the sound.
STADIUM: Adds clarity and spreads the sound, like in an outdoor stadium.

SEA modes:

- ROCK:** Boosts low and high frequency. Good for acoustic music.
POP: Good for vocal music.
CLASSIC: Good for classical music.

KARAOKE: Vocal masking. (See “Singing Along” on page 22.)

OFF: Cancels the sound mode.

Listening to FM and AM Broadcasts

Tuning in a Station

On the unit ONLY:

1 Press FM/AM.

The unit automatically turns on and tunes in the previously tuned station (either FM or AM). (For CA-MXJ300 only, the Powered Rolling Panel automatically opens.)

- Each time you press the button, the band alternates between FM and AM.

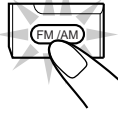

2 Press and hold TUNING - / + for more than 1 second.

The unit starts searching for stations and stops when a station of sufficient signal strength is tuned in.

If a program is broadcast in stereo, the ST (stereo) indicator lights up.

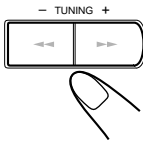

To stop during searching, press TUNING - / +.



When you press TUNING - / + briefly and repeatedly the frequency changes step by step.

To change the FM reception mode

When an FM stereo broadcast is hard to receive or noisy, press FM MODE on the remote control so that the MONO indicator lights up on the display. Reception improves.

FM MODE



To restore the stereo effect, press FM MODE again so that the MONO indicator goes off.

In this stereo mode, you can hear stereo sounds when a program is broadcast in stereo.

Presetting Stations

You can preset 30 FM and 15 AM stations.

In some cases, test frequencies have been already memorized for the tuner since the factory examined the tuner preset function before shipment. This is not a malfunction. You can preset the stations you want into memory by following the presetting method.

- There is a time limit in doing the following steps. If the setting is canceled before you finish, start from step 1 again.

1 Tune in the station you want to preset.

- See "Tuning in a Station" above.

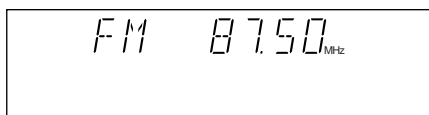

2 Press SET.



3 Press PRESET - / + to select a preset number.

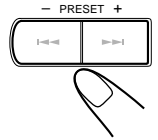
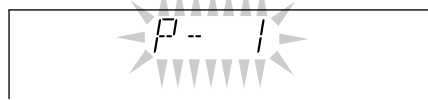

4 Press SET again.



The tuned station in step 1 is stored in the preset number selected in step 3.

- Storing a new station on a used number erases the previously stored one.



When you unplug the AC power cord or if a power failure occurs

The preset stations will be erased in a few days. If this happens, preset the stations again.

Tuning in a Preset Station

1 Press FM/AM.

The unit automatically turns on and tunes in the previously tuned station (either FM or AM). (For CA-MXJ300 only, the Powered Rolling Panel automatically opens.)

- Each time you press the button, the band alternates between FM and AM.

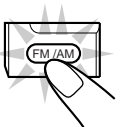

2 Select a preset number.

On the unit:

Press PRESET - / +.

On the remote control:

Press the number buttons.

For preset number 5, press 5.

For preset number 15, press +10 then 5.

For preset number 20, press +10, then 10.

For preset number 25, press +10, +10, then 5.

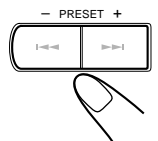

Playing Back CDs

Loading CDs

1 Press ▲ for the disc tray (CD 1 to CD 3) you want to load a CD onto.

The unit automatically turns on and the disc tray comes out. (For CA-MXJ300 only, the Powered Rolling Panel also opens automatically.)

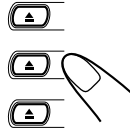

2 Place a disc correctly on the circle of the disc tray, with its label side up.

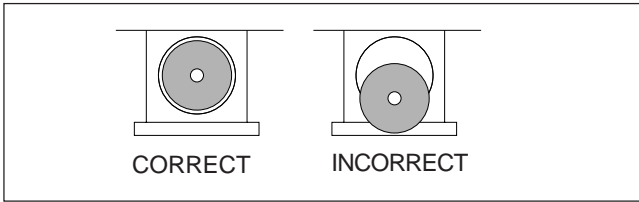

- When using a CD single (8 cm), place it on the inner circle of the disc tray.

3 Press the same ▲ you have pressed in step 1.

The disc tray closes, and the corresponding disc number indicator (CD 1 to CD 3) lights up on the display.

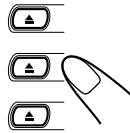

4 Repeat steps 1 to 3 to place other CDs.



When loading more than one CD continuously

When you press ▲ for the next tray you want to place another CD onto, the first disc tray automatically closes and then the next tray comes out.



About the disc indicators

Each disc indicator corresponds to the disc tray of the same number.

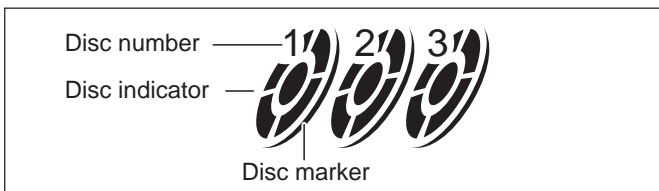

- The disc marker lights up for the disc number you have selected.
- The disc indicator flashes while the corresponding CD is being played.
- The disc indicator goes off when the unit has detected that there is no CD on the corresponding disc tray.

Playing Back the Entire Discs — Continuous Play

You can play CDs continuously.

1 Load CDs.

2 Press one of the disc number buttons (CD 1, CD 2, and CD 3) for the disc you want to play.

CD play starts from the first track of the selected disc.

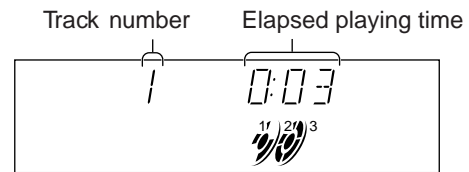
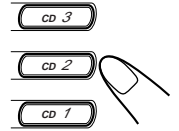

- Pressing CD ►/|| instead of the disc number buttons starts playing back if a CD is on the trays.

To stop during play, press ■ on the unit (or CD ■/CLEAR on the remote control).

To remove the disc, press ▲ for the corresponding disc tray.



CD playback sequence

When 3 CDs are loaded in the disc trays, they are played in one of the following sequences.

- When CD 1 is pressed : CD 1 ⇒ CD 2 ⇒ CD 3 (then stops)
- When CD 2 is pressed : CD 2 ⇒ CD 3 ⇒ CD 1 (then stops)
- When CD 3 is pressed : CD 3 ⇒ CD 1 ⇒ CD 2 (then stops)
- * When only 2 CDs are loaded, they are played in the same order, but the disc tray without a CD is skipped.

Basic CD Operations

While playing a CD, you can do the following operations.

To exchange CDs during playback of another

Press ▲ corresponding to a CD, not playing or selected currently, to eject and exchange the CD.

If you exchange CDs during play, the current play will not stop until all CDs you have exchanged are played.

To stop play for a moment

Press CD ►/||.

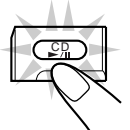

While pausing, the elapsed playing time flashes on the display.

To resume play, press CD ►/|| again.

To locate a particular point in a track

During play, press and hold ◀◀ or ▶▶.

- ◀◀: Fast reverses the disc.
- ▶▶: Fast forwards the disc.

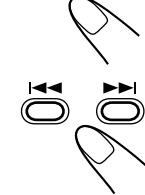
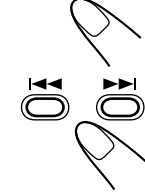

To go to another track

Press ◀◀ or ▶▶ repeatedly before or during playback.

- ◀◀: Goes back to the beginning of the current or previous tracks.
- ▶▶: Skips to the beginning of the next or succeeding tracks.



notes If you press and hold ◀◀ / ▶▶ before playing you can change the tracks continuously.

To go to another track directly using the number buttons

Pressing the number button(s) before or during play allows you to start playing the track number you want. When a track number button is pressed, CD play starts from the track of the currently selected disc.

- Ex.: For track number 5, press 5.
 For track number 15, press +10 then 5.
 For track number 20, press +10, then 10.
 For track number 32, press +10, +10, +10, then 2.

1 2 3

4 5 6

7 8 9

10 +10

Programming the Playing Order of the Tracks — Program Play

You can arrange the order in which the tracks play before you start playing. **You can program up to 32 tracks.**

- To use Repeat play for Program play, press REPEAT after starting Program play.

1 Load discs.

- If the current playing source is not the CD player, press CD ▶/II, then ■ on the unit (or CD ■/CLEAR on the remote control) before going to the next step.

2 Select the Program play mode.

On the unit:

Press PROGRAM.



On the remote control:

Press PLAY MODE repeatedly until the PRGM indicator lights on the display. Each time you press the button, the CD play mode changes as follows:

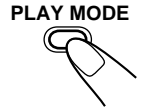

Program play → Random play → Continuous play → (back to the beginning)



- If a program has been stored in memory, the program is called up.

3 Press one of the disc number buttons (CD 1, CD 2, and CD 3) to select the disc number you want to play.

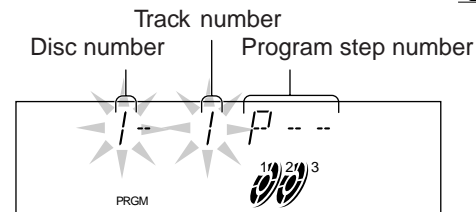
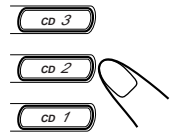

4 Select a track from the CD selected in the above step.

On the unit:

Press ◀◀ or ▶▶ to select the track number, then press SET.

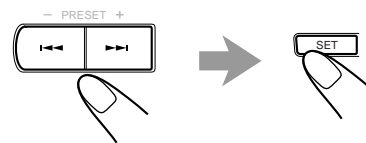

On the remote control:

Press the number buttons.

- For how to use the number buttons, see "To go to another track directly using the number buttons" described to the left.

1 2 3

4 5 6

7 8 9

10 +10

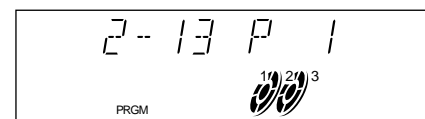

5 Program other tracks you want.

- To program tracks from the same disc, repeat step 4.
- To program tracks from a different disc, repeat steps 3 and 4.

6 Press CD ▶/II.

The tracks are played in the order you have programmed.

To stop during play, press ■ on the unit (or CD ■/CLEAR on the remote control).

To exit from program play mode

On the unit:

Press PROGRAM again before or after play so that the unit enters Continuous play mode.

On the remote control:

Press PLAY MODE repeatedly until all the CD play mode indicator go off from the display.

- The program you have made is stored in memory until you erase the program.

To check the program contents

Before playing, you can check the program contents by pressing ◀◀ or ▶▶ on the remote control.

- ▶▶: Shows the programmed tracks in the programmed order.
- ◀◀: Shows them in the reverse order.

To modify the program

Before play, you can erase the programmed tracks shown on the display by pressing CANCEL.

- Each time you press the button, the programmed track shown on the display is erased from the program.



To add tracks in the program before play, simply select the disc numbers and the track numbers you want to add by following steps 3 and 4 of the programming procedure on page 16.

To erase the entire program before or after play, press ■ on the unit (or CD ■/CLEAR on the remote control).

“PROGRAM” appears on the display.

- Ejecting a CD will also erase the track numbers programmed from the ejected CD.



If you try to program a 33rd step

“FULL” will appear on the display.



If your entry is ignored

You have tried to program a track from an empty tray, or a track number that does not exist on the CD (for example, selecting track 14 on a CD that only has 12 tracks). Such entries are ignored.

Playing at Random — Random Play

The tracks of all loaded CDs will play at random.

- To use Repeat play for Random play, press REPEAT after starting Random play.

1 Prepare CDs.

- If the current playing source is not the CD player, press CD ▶/II, then ■ on the unit (or CD ■/CLEAR on the remote control) before going to the next step.

2 Select the Random play mode.

On the unit:

Press RANDOM.

On the remote control:

Press PLAY MODE repeatedly until the RANDOM indicator lights on the display. Each time you press the button, the CD play mode changes as follows:

Program play → Random play → Continuous play → (back to the beginning)

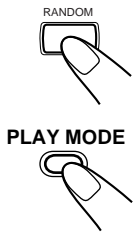

3 Press CD ▶/II.

The tracks are played at random.

Random play ends when all the tracks are played once.

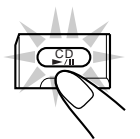

To stop during play, press ■ on the unit (or CD ■/CLEAR on the remote control).

- Random play also stops when one of the disc trays is opened.

To exit from random play mode

On the unit:

Press RANDOM again before or after play so that the unit enters Continuous play mode.

On the remote control:

Press PLAY MODE repeatedly until all the CD play mode indicator go off from the display.



Even if you press ◀◀

You cannot go back to the previous tracks during Random play.

- If you press ▶▶, you can go to next random tracks.

Repeating Tracks or CDs — Repeat Play

You can have all the CDs, the program or the individual track currently playing repeat as many times as you like.

To repeat play, press REPEAT during or before playing. To use Repeat play for Program play and Random play, press the button after starting playback.

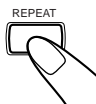

- Each time you press the button, Repeat play mode changes as follows, and the following indicator lights up on the display:

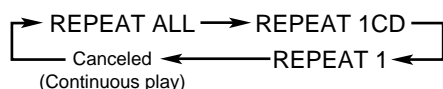

REPEAT ALL: Repeats all the tracks on all the CDs (continuously or at random), or all the tracks in the program.

REPEAT 1CD*: Repeats all the tracks on one CD.

REPEAT 1: Repeats one track on one CD.

- * REPEAT 1CD is not used for Program play and Random play.

To cancel Repeat play, press REPEAT repeatedly until the REPEAT indicator (REPEAT ALL, REPEAT 1CD, or REPEAT 1) goes off from the display.

- Repeat play is also canceled when you select Program play or Random play.

Prohibiting Disc Ejection — Tray Lock

You can prohibit CD ejection from the unit and can lock discs.

- This operation is possible only using the buttons on the unit.

To prohibit disc ejection, press ▲ for any disc tray while holding ■. (If there is any disc tray opened, close it first.) “LOCKED” appears for a while, and the loaded CDs are locked.

To cancel the prohibition and unlock the CDs, press ▲ for any disc tray while holding ■. “UNLOCKED” appears for a while, and the loaded CDs are unlocked.



If you try to eject CDs

“LOCKED” appears to inform you that the Tray Lock is in use.

Playing Back Tapes

This unit provides two types of cassette deck: Deck A for one-way playing only and deck B for Reverse Mode playing as well as one-way playing.

You can play back type I, type II and type IV tapes without changing any settings.

Playing Back a Tape

1 Press EJECT (▲) for the deck you want to use.

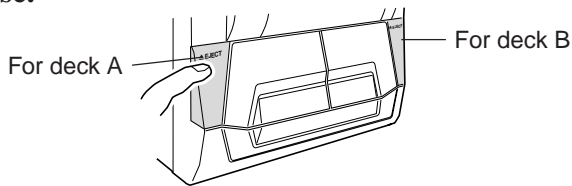

2 Put a cassette in, with the exposed part of the tape down.

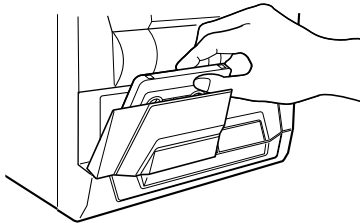

3 Close the cassette holder gently.

If you put cassettes in both decks A and B, the last deck you have put a cassette into is selected.

To operate the other deck, press TAPE A/B (or TAPE A or TAPE B on the remote control).

4 On the unit:

Press TAPE ◀▶.

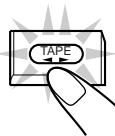

On the remote control:

Press TAPE ▶ for forward direction playback, or press TAPE ◀ for reverse direction playback.

When the deck A is selected:

The tape plays only the front side and the tape direction indicator (▶) starts flashing slowly.

When the tape plays to the end, the deck automatically stops.

When the deck B is selected:

The tape play starts and the tape direction indicator (◀▶) starts flashing slowly to indicate the tape running direction.

- When using TAPE ◀▶ on the unit:
Each time you press the button, the tape direction changes:
 - ▶ : plays the front side.
 - ◀ : plays the reverse side.

When the tape plays to the end, the deck automatically stops if the Reverse Mode is not on. (See “To play both sides repeatedly — Reverse Mode.”)

To stop during play, press ■ (or TAPE ■ on the remote control).

To operate the other deck, press TAPE A/B (or TAPE A or TAPE B on the remote control), then TAPE ◀▶.

To fast wind to the left or to the right, press |◀◀ or ▶▶| (or ◀◀ or ▶▶ on the remote control).

The tape direction indicator (◀▶) starts flashing quickly on the display.

To remove the cassette, press ▲ EJECT for deck A or EJECT ▲ for deck B.

To play both sides repeatedly — Reverse Mode

Reverse Mode works for deck B.

When it is in use, the tape automatically reverses at the end of a side and the unit starts playing the other side of the tape, and repeats the same process.

To use Reverse Mode, press REVERSE MODE repeatedly so that the Reverse Mode indicator on the display lights up as — (↻).

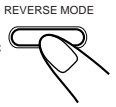

- Each time you press the button, Reverse Mode changes as follows:

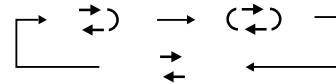

- ↻ : The cassette deck automatically stops after playing both sides of the tape. (Stops when playback in the ◀ direction is finished.)
- ↻ : The cassette deck continues to play both sides of the tape until the ■ button is pressed.
- ↻ : The cassette deck automatically stops after playing one side of the tape.



The use of the C-120 or thinner tape is not recommended, since characteristic deterioration may occur and this tape easily jams in the pinch-rollers and the capstans.

IMPORTANT:

- It may be unlawful to record or play back copyrighted material without the consent of the copyrighted owner.
- The recording level is automatically set correctly, so it is not affected by the VOLUME control. Thus, during recording you can adjust the sound you are actually listening to without affecting the recording level.
- While recording, you can hear sound modes and/or the active bass extension effect through the speakers or headphones. However, the sound is recorded without these effects (see page 13).
- If recordings you have made have excessive noise or static, the unit may be too close to a TV. Increase the distance between the TV and the unit.
- You can use type I and II tapes for recording.

To protect your recording

Cassettes have two small tabs on the back to protect unexpected erasure or re-recording.

To protect your recording, remove these tabs.

To re-record on a protected tape, cover the holes with adhesive tape.

When using type II tape, be careful not to cover the holes used to detect the tape type.

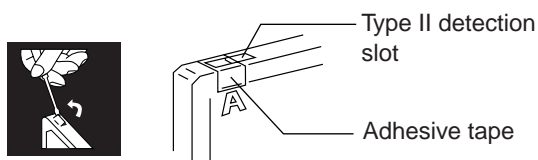

Recording Tapes on Deck B



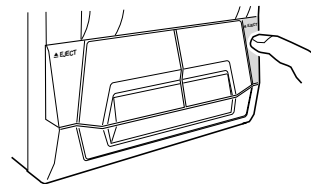

1 Press EJECT for the deck B.



2 Put in a recordable cassette, with the exposed part of the tape down.

3 Close the cassette holder gently.

4 Check the tape direction of deck B.

- When using the unit:
If the tape direction is not correct, press TAPE   twice then  to change the tape direction.
- If you want to record on both sides of a tape, press REVERSE MODE until the  indicator is lit.

5 Start playing the source — FM, AM*, CD player, deck A, or auxiliary equipment connected to AUX jacks.

- When the source is CD, you can also use CD Direct Recording (see page 21).
- When the source is deck A, you can also use the dubbing method. (See “Dubbing Tapes” on page 21.)

* See “To record an AM station – Beat Cut” on page 21.

6 Start recording.

On the unit:

Press REC START/STOP.

The **REC** indicator lights up on the display and recording starts.



On the remote control:

1) Press REC PAUSE.

The **REC** indicator starts flashing on the display.



2) Press TAPE or TAPE .

The **REC** indicator stops flashing and remains lit, and recording starts.

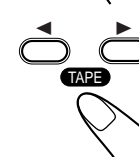

To stop during recording, press REC START/STOP again, or press  on the unit (or TAPE  on the remote control).

To stop recording temporarily (except when the playback source is deck A), press REC PAUSE on the remote control.

The **REC** indicator flashes on the display.

To resume recording, press TAPE ◀▶ on the unit (or TAPE ◀ or TAPE ▶ on the remote control). The **REC** indicator stops flashing and remains lit.

To remove the cassette, press EJECT ▲ for deck B.

To record on both sides — Reverse Mode

Press REVERSE MODE so that the Reverse Mode indicator lights up as — ↺.

- When using the Reverse Mode for recording, start recording in the forward (▶) direction first. Otherwise, recording will stop when recording is done only on one side (reverse) of the tape.

To cancel Reverse Mode, press the button again so that the Reverse Mode indicator lights up as — ↻.

To record an AM station — Beat Cut

While recording an AM broadcast, beats may be heard (which are never heard when listening to the broadcast without recording it).

If this occurs, press PROGRAM repeatedly, while recording, until the beats are reduced.

- Each time you press the button, the display changes to show the following:

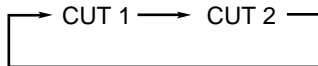

Dubbing Tapes

When dubbing tapes, make sure that the playback direction of deck A and deck B are the same.

1 Press TAPE ◀▶, then ■.

2 Put the source cassette in deck A, and a recordable cassette into deck B.

- Put the cassettes in both decks so that the tapes will run in the forward (▶) direction.

3 Press DUBBING.

Dubbing starts.

To stop during dubbing, press ■ on the unit (or TAPE ■ on the remote control).

To remove the cassette, press ▲ EJECT for deck A and EJECT ▲ for deck B.

To record on both sides — Reverse Mode

Press REVERSE MODE so that the Reverse Mode indicator lights up as — ↺.

To cancel Reverse Mode, press the button again so that the Reverse Mode indicator lights up as — ↻.

CD Direct Recording

Everything on the CD goes onto the tape in the order it is on the CD, or according to the order you have made for Program play.

1 Put a recordable cassette into deck B.

2 Place a disc correctly on the circle of the disc tray, with its label side up.

3 Press one of the disc number buttons (CD 1 to CD 3) to select the disc, then ■.

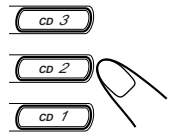

4 Press CD REC START.

“CD REC” appears, and the **REC** indicator lights up on the display.

Deck B starts recording and the CD player starts playing.

When the recording is done, “CD REC FINISHED” appears on the display, and the CD player and deck B stop.



To stop during CD Direct Recording, press ■ on the unit (or TAPE ■ on the remote control).

To remove the cassette, press EJECT ▲ for deck B.

To record on both sides — Reverse Mode

Press REVERSE MODE so that the Reverse Mode indicator lights up as — ↺.

- When using the Reverse Mode for CD Direct Recording, put a recordable cassette tape into deck B with the front side facing the holder and start recording in the forward (▶) direction first. When the tape reaches its end while recording a song in the forward direction (▶), the last song will be recorded at the beginning of the reverse side (◀).

If you start recording on the reverse side (◀), recording will stop when recording is done only on one side (reverse) of the tape.

To cancel Reverse Mode, press the button again so that the Reverse Mode indicator lights up as — ↻.

Using the Microphone

You can enjoy singing along (Karaoke) and microphone mixing.

IMPORTANT:

- Always set MIC LEVEL to MIN when connecting or disconnecting the microphone.
- When you do not use the microphone, keep the microphones unconnected.

Singing Along

Vocal Masking

Vocal Masking reduces the lead vocal of the playing source, and allows you to replace it by singing into the microphone as the music plays.

On the unit ONLY:

1 Rotate MIC LEVEL to MIN.



2 Connect the microphone (not supplied) by plugging it into the MIC jack.

3 Press SOUND MODE repeatedly until “KARAOKE” appears on the display.

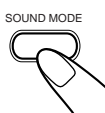

The karaoke indicator () also lights up on the display.

4 Start playing the source — CD, tape, or other connected component.

5 Rotate MIC LEVEL and VOLUME controls as you sing into the microphone.

- By pressing REC START/STOP, you can record your singing along if you want. (For more details, see page 20.)

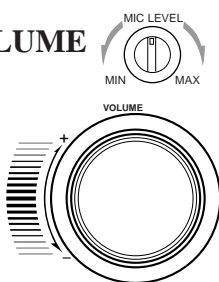

To apply an echo to your voice

Press SHIFT, then press ECHO on the remote control so that the echo () indicator lights up on the display.

Each time you press ECHO, the echo indicator turns on and off.

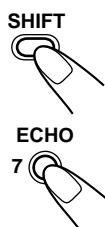

If howling or squealing (feedback) occurs while using the microphone

Take the following actions to prevent these noises.

- Adjust the MIC LEVEL and VOLUME controls
- Avoid pointing the microphone towards the speakers.



If you use the following sources as the playing source for Vocal Masking, you cannot get the satisfactory results

- Radio programs — a radio signal is not as reliable as the signals coming from a tape or CD.
- Monaural sources.
- Poorly dubbed tapes.
- Sources recorded with duets, strong echo, a chorus, or only a few instruments.

Microphone mixing

When you sing along with multiplex tapes or CDs, follow the procedure below:

On the unit ONLY:

1 Rotate MIC LEVEL to MIN.



2 Connect the microphone (not supplied) by plugging it into the MIC jack.

3 Start playing the source — CD, tape or other connected component.

4 Rotate MIC LEVEL and VOLUME as you sing into the microphone.

- By pressing REC START/STOP, you can record your singing along if you want. (For more details, see page 20.)

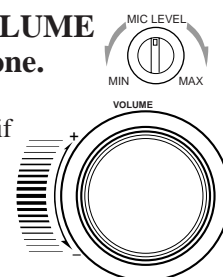

To use microphone only

Without any background sound, you can use your microphone, and record it if you want.

1 Rotate MIC LEVEL to MIN.

2 Connect the microphone (not supplied) by plugging it into the MIC jack.

3 Press CD ►/II, then ■.

No background sound will be heard.

4 Rotate MIC LEVEL and VOLUME as you sing or speak into the microphone.

- By pressing REC START/STOP, you can record your singing along if you want. (For more details, see page 20.)

Using the Timers

There are three timers available — Recording Timer, Daily Timer, and Sleep Timer.

Before using the timers, you need to set the clock built in the unit. (See page 11.)

Using Daily Timer

With Daily Timer, you can wake to your favorite music or radio program.

How Daily Timer actually works

The unit automatically turns on, set the volume level to the preset level, and starts playing the specified source when the on-time comes (the ☹ indicator flashes just before the on-time, and continues flashing while the timer is operating). Then, when the off-time comes (“OFF” flashes just before the off-time), the unit automatically turns off (stands by).

The timer setting remains in memory until you change it.

- There is a time limit in doing the following steps. If the setting is canceled before you finish, start from step 1 again.
- If you have made a mistake while setting timer, press CANCEL. (However, this does not always work. If CANCEL does not work, press CLOCK/TIMER repeatedly and start from step 1 again.)

On the unit:

1 Press CLOCK/TIMER until “DAILY” appears on the display.

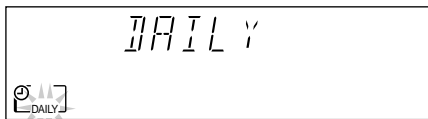

The DAILY indicator also starts flashing on the display.

- Each time you press the button, the timer setting mode changes as follows:

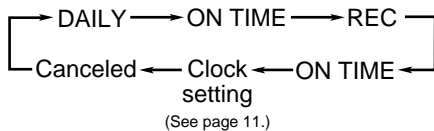

2 Press CLOCK/TIMER again.

“ON TIME” appears for 2 seconds, then the unit enters on-time setting mode.

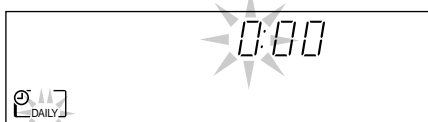

3 Set the on-time you want the unit to turn on.

- 1) Press ◀◀ or ▶▶ to set the hour, then press SET.
- 2) Press ◀◀ or ▶▶ to set the minute, then press SET.
“OFF TIME” appears for 2 seconds, then the unit enters off-time setting mode.

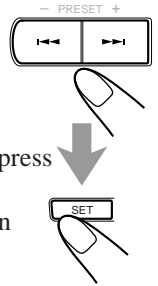

4 Set the off-time you want the unit to turn off (on standby).

- 1) Press ◀◀ or ▶▶ to set the hour, then press SET.
- 2) Press ◀◀ or ▶▶ to set the minute, then press SET.
The unit enters source selecting mode.

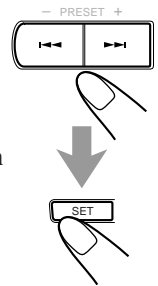

5 Press ◀◀ or ▶▶ to select the source to play, then press SET.

- Each time you press ◀◀ or ▶▶, the source changes as follows:

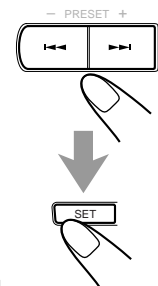
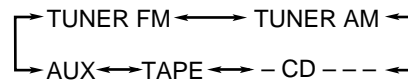

- TUNER FM: tunes into a specified preset FM station. → go to step 6.
- TUNER AM: tunes into a specified preset AM station. → go to step 6.
- CD - - -: plays a disc from a specified track of a specified disc. → go to step 6.
 - Make sure there is a CD on the selected disc number tray.
- TAPE: plays a tape in deck A or B. → go to step 7.
 - Make sure that a tape is in the deck whose deck indicator (A or B) is lit on the display.
 - Make sure that the tape direction is correct.
- AUX: plays an external source. → go to step 7.
 - To use this setting, the external component has to be equipped with the timer function.

6 When selecting “- CD - - -”

- 1) Press ◀◀ or ▶▶ to select the disc number, then press SET.
- 2) Press ◀◀ or ▶▶ to set the track number, then press SET.

The unit enters volume setting mode.

When selecting “TUNER FM” or “TUNER AM”

Press ◀◀ or ▶▶ to select the preset station number, then press SET.

The unit enters volume setting mode.

7 Press ◀◀ or ▶▶ to set the volume level.

- You can select the volume level from among four levels. If you select “VOL -- --,” the volume is set to the last level when the unit has been turned off.



8 Press SET to complete the Daily Timer setting.

The DAILY indicator stops flashing and remains lit. The settings you have done are shown on the display in sequence.

9 Press ⏻/⏻ (standby/on) to turn off the unit (on standby) if you have set the Daily Timer with the unit turned on.

To turn on or off Daily Timer after its setting is done

1 Press CLOCK/TIMER repeatedly until “DAILY” appears on the display.

2 To turn off the Daily Timer, press CANCEL.

The DAILY indicator goes off and “OFF” appears on the display.

The Daily Timer is canceled, but the setting for the Daily Timer remains in memory.

To turn on the Daily Timer, press SET.

The DAILY indicator lights up on the display. The settings you have done are shown on the display in sequence for your confirmation.



If the unit is turned on when the timer-on time comes Daily Timer does not work.

On the remote control:

1 Press SHIFT.



2 Press TIMER.



The DAILY indicator also starts flashing on the display.

- Each time you press the button, the timer setting mode changes as follows:

DAILY → ON TIME → REC → ON TIME → Clock setting (See page 11.) → Canceled

3 Press TIMER again.

“ON TIME” appears for 2 seconds, then the unit enters on-time setting mode.

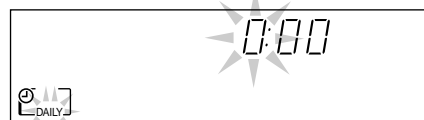
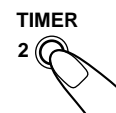

4 Set the on-time you want the unit to turn on.

- 1) Press SELECT - or SELECT + to set the hour, then press SET.

- 2) Press SELECT - or SELECT + to set the minute, then press SET.

“OFF TIME” appears for 2 seconds, then the unit enters off-time setting mode.



5 Set the off-time you want the unit to turn off (on standby).

- 1) Press SELECT - or SELECT + to set the hour, then press SET.

- 2) Press SELECT - or SELECT + to set the minute, then press SET.

The unit enters source selecting mode.



6 Press SELECT – or SELECT + to select the source to play, then press SET.

- Each time you press SELECT – or SELECT +, the source changes as follows:

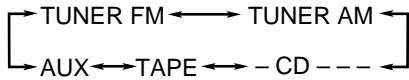

- TUNER FM: tunes into a specified preset FM station. → go to step 7.
- TUNER AM: tunes into a specified preset AM station. → go to step 7.
- CD – – –: plays a disc from a specified track of a specified disc. → go to step 7.
- Make sure there is a CD on the selected disc number tray.
- TAPE: plays a tape in deck A or B. → go to step 8.
- Make sure that a tape is in the deck whose deck indicator (A or B) is lit on the display.
 - Make sure that the tape direction is correct.
- AUX: plays an external source. → go to step 8.
- To use this setting, the external component has to be equipped with the timer function.

7 When selecting “– CD – – –”

- Press SELECT – or SELECT + to select the disc number, then press SET.
- Press SELECT – or SELECT + to set the track number, then press SET. The unit enters volume setting mode.

When selecting “TUNER FM” or “TUNER AM”

Press SELECT – or SELECT + to select the preset station number, then press SET. The unit enters volume setting mode.

8 Press SELECT – or SELECT + to set the volume level.

- You can select the volume level from among four levels. If you select “VOL – – –,” the volume is set to the last level when the unit has been turned off.



9 Press SET to complete the Daily Timer setting.

The DAILY indicator stops flashing and remains lit. The settings you have done are shown on the display in sequence.

10 Press ⏻/⏻ (standby/on) to turn off the unit (on standby) if you have set the Daily Timer with the unit turned on.

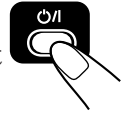

Using Recording Timer

With Recording Timer, you can make a tape of a radio broadcast automatically.

How Recording Timer actually works

The unit automatically turns on, tunes into the specified station, sets the volume level to “MIN,” and starts recording when the on-time comes (the Ⓞ indicator flashes just before the on-time, and continues flashing while the timer is operating). Then, when the off-time comes (“OFF” appears just before the off-time), the unit automatically turns off (stands by).

The timer setting remains in memory until you change it.

- There is a time limit in doing the following steps. If the setting is canceled before you finish, start from step 1 again.
- If you have made a mistake while setting the timer, press CANCEL. (However, this does not always work. If CANCEL does not work, press CLOCK/TIMER repeatedly and start from step 1 again.)

On the unit:

1 Put a recordable cassette into deck B.

2 Press CLOCK/TIMER until “REC” appears on the display.

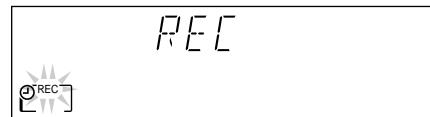

The REC indicator also starts flashing on the display.

- Each time you press the button, the timer setting mode changes as follows:

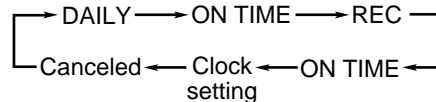

(See page 11.)

3 Press CLOCK/TIMER again.

“ON TIME” appears for 2 seconds, then the unit enters on-time setting mode.

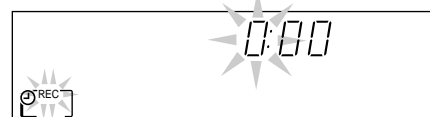
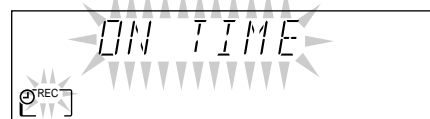

4 Set the on-time you want the unit to turn on.

- 1) Press **◀◀** or **▶▶** to set the hour, then press **SET**.
- 2) Press **◀◀** or **▶▶** to set the minute, then press **SET**.
“OFF TIME” appears for 2 seconds, then the unit enters off-time setting mode.

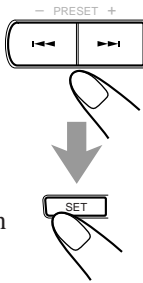

5 Set the off-time you want the unit to turn off (on standby).

- 1) Press **◀◀** or **▶▶** to set the hour, then press **SET**.
- 2) Press **◀◀** or **▶▶** to set the minute, then press **SET**.
The unit enters preset station selecting mode.

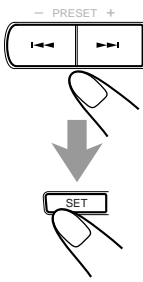

6 Select the preset station.

- 1) Press **◀◀** or **▶▶** to select the band (“TUNER FM” or “TUNER AM”), then press **SET**.
- 2) Press **◀◀** or **▶▶** to select a preset channel number, then press **SET**.
The REC indicator stops flashing and remains lit. The settings you have done are shown on the display in sequence.

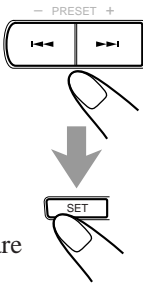

7 Press **⏻/⏻** (standby/on) to turn off the unit (on standby) if necessary.



If you want to listen to another source while recording

Press REC START/STOP to stop recording. Without stopping it, you cannot change the source.

To turn on or off Recording Timer after its setting is done

- 1 Press **CLOCK/TIMER** repeatedly until “REC” appears on the display.

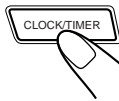

- 2 To turn off the Recording Timer, press **CANCEL** (on the unit only).



The REC indicator goes off and “OFF” appears on the display.
The Recording Timer is canceled, but the setting for the Recording Timer remains in memory.

To turn on the Recording Timer, press **SET**.

The REC indicator lights up on the display. The settings you have done are shown on the display in sequence for your confirmation.



On the remote control:

- 1 Put a recordable cassette into deck B.

- 2 Press **SHIFT**.



- 3 Press **TIMER** until “REC” appears on the display.

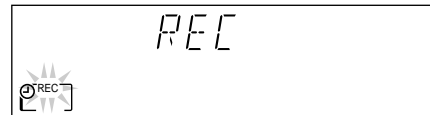
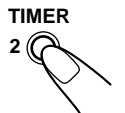

The REC indicator also starts flashing on the display.

- Each time you press the button, the timer setting mode changes as follows:

DAILY → ON TIME → REC → ON TIME → Clock setting (See page 11.) → Canceled

- 4 Press **TIMER** again.

“ON TIME” appears for 2 seconds, then the unit enters on-time setting mode.

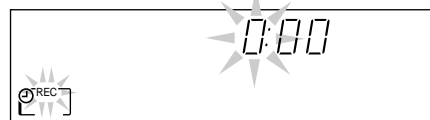
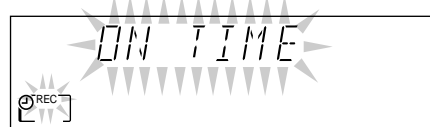
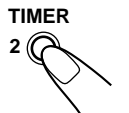

- 5 Set the on-time you want the unit to turn on.

- 1) Press **SELECT -** or **SELECT +** to set the hour, then press **SET**.
- 2) Press **SELECT -** or **SELECT +** to set the minute, then press **SET**.
“OFF TIME” appears for 2 seconds, then the unit enters off-time setting mode.

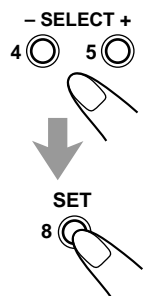

- 6 Set the off-time you want the unit to turn off (on standby).

- 1) Press **SELECT -** or **SELECT +** to set the hour, then press **SET**.
- 2) Press **SELECT -** or **SELECT +** to set the minute, then press **SET**.
The unit enters source selecting mode.

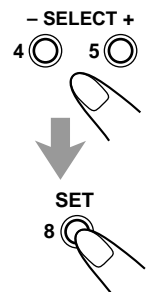

7 Select the preset station.

- 1) Press SELECT – or SELECT + to select the band (“TUNER FM” or “TUNER AM”), then press SET.
- 2) Press SELECT – or SELECT + to select a preset channel number, then press SET. The REC indicator stops flashing and remains lit. The settings you have done are shown on the display in sequence.



8 Press $\odot/|$ to turn off the unit (on standby) if necessary.



Using Sleep Timer

With Sleep Timer, you can fall asleep to music. You can set Sleep Timer when the unit is turned on.

How Sleep Timer actually works

The unit automatically turns off after the specified time length passes.

On the remote control ONLY:

1 Press SLEEP.

The time length until the shut-off time appears and the SLEEP indicator starts flashing on the display.

- Each time you press the button, the time length changes as follows:

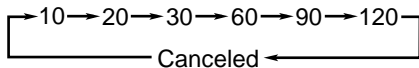

2 Wait for about 5 seconds after specifying the time length.

The SLEEP indicator stops flashing and remains lit.

To check the remaining time until the shut-off time, press SLEEP once so that the remaining time until the shut-off time appears for about 5 seconds.

To change the shut-off time, press SLEEP repeatedly until the desired time length appears on the display.

To cancel the setting, press SLEEP repeatedly so that the SLEEP indicator goes off.

- Sleep Timer is also canceled when you turn off the unit.

Timer Priority

Since each timer can be set separately, you may wonder what happens if the setting for these timers overlaps. Here are examples.

• Recording Timer has priority over Daily Timer and Sleep Timer.

If Daily Timer is set to come on while Recording Timer is operating, Daily Timer will not come on at all.

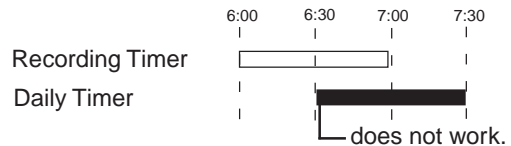

If Recording Timer is set to come on while Sleep Timer is operating, Sleep Timer will not work (the SLEEP indicator does not go off).

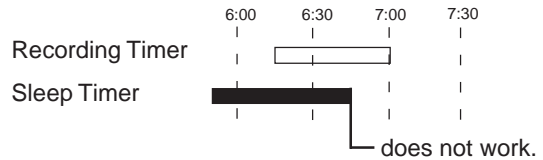

Maintenance

To get the best performance of the unit, keep your discs, tapes, and mechanism clean.

Handling discs



- Remove the disc from its case by holding it at the edge while pressing the center hole lightly.
- Do not touch the shiny surface of the disc, or bend the disc.
- Put the disc back in its case after use to prevent warping.

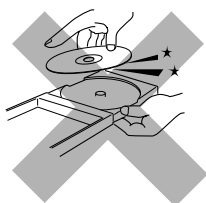

- Be careful not to scratch the surface of the disc when placing it back in its case.
- Avoid exposure to direct sunlight, temperature extremes, and moisture.



To clean the disc

Wipe the disc with a soft cloth in a straight line from center to edge.



DO NOT use any solvent — such as conventional record cleaner, spray, thinner, or benzene — to clean the disc.

Handling cassette tapes

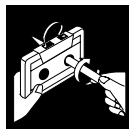

- If the tape is loose in its cassette, take up the slack by inserting a pencil in one of the reels and rotating.
- If the tape is loose, it may get stretched, cut, or caught in the cassette.



- Be careful not to touch the tape surface.



- Avoid the following places to store the tape:
 - In dusty places
 - In direct sunlight or heat
 - In moist areas
 - Near a magnet

Cassette decks

If the heads, capstans, and pinch rollers of the cassette decks become dirty, the following will occur:

- Impaired sound quality
- Discontinuous sound
- Fading
- Incomplete erasure
- Difficulty in recording

To clean the heads, capstans, and pinch rollers

Use a cotton swab moistened with alcohol.

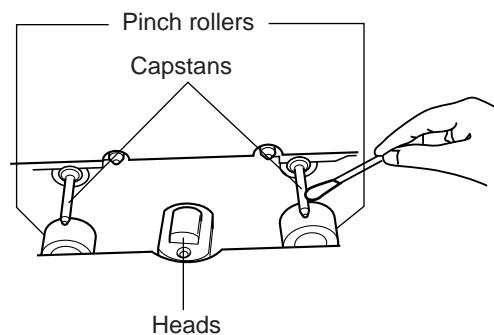

To demagnetize the heads

Turn off the unit, and use a head demagnetizer (available at electronics and record shops).

Troubleshooting

If you are having a problem with your unit, check this list for a possible solution before calling for service.

If you cannot solve the problem from the hints given here, or the unit has been physically damaged, call a qualified person, such as your dealer, for service.

Symptom	Cause	Action
No sound is heard.	Connections are incorrect or loose.	Check all connections and make corrections. (See pages 8 to 10.)
Hard to listen to broadcasts because of noise.	<ul style="list-style-type: none"> Antennas are disconnected. The AM loop antenna is too close to the unit. The FM antenna is not properly extended and positioned. 	<ul style="list-style-type: none"> Reconnect the antennas correctly and securely. Change the position and direction of the AM loop antenna. Extend the FM antenna at the best position.
The disc sound is discontinuous.	The disc is scratched or dirty.	Clean or replace the disc. (See page 28.)
The disc tray does not open or close.	<ul style="list-style-type: none"> The AC power cord is not plugged in. Trays are locked. 	<ul style="list-style-type: none"> Plug the AC power cord. Unlock the trays. (See page 18.)
The disc does not play.	The disc is placed upside down.	Place the disc with the label side up.
The cassette holders cannot be opened.	Power supply from the AC power cord has been cut off while the tape was running.	Turn on the unit.
Impossible to record.	Small tabs on the back of the cassette are removed.	Cover the holes with adhesive tape.
Stereo effect is lost.	Vocal Masking is activated.	Cancel the Vocal Masking. (See page 22.)
Operations are disabled.	The built-in microprocessor may malfunction due to external electrical interference.	Unplug the AC power cord and then plug it back in.
Unable to operate the unit from the remote control unit.	<ul style="list-style-type: none"> The path between the remote control unit and the remote sensor on the unit is blocked. The batteries are exhausted. 	<ul style="list-style-type: none"> Remove the obstruction. Replace the batteries.

Amplifier

Output Power

CA-MXJ300: 70 W per channel, min. RMS, both channels driven into 6 Ω at 1 kHz with no more than 10% total harmonic distortion

CA-MXJ200: 40 W per channel, min. RMS, both channels driven into 6 Ω at 1 kHz with no more than 10% total harmonic distortion

Audio input sensitivity/Impedance (at 1 kHz)

AUX: 300 mV/50 k Ω

MIC: 2.5 mV/5 k Ω

Speakers/Impedance: 6 Ω – 16 Ω

Tuner

FM tuning range: 87.50 MHz – 108.00 MHz

AM tuning range:

For Saudi Arabia:

At 9 kHz intervals : 531 kHz – 1,602 kHz

At 10 kHz intervals : 530 kHz – 1,600 kHz

For other countries:

At 9 kHz intervals : 531 kHz – 1,710 kHz

At 10 kHz intervals : 530 kHz – 1,710 kHz

CD player

CD Capacity: 3 CDs

Dynamic range: 85 dB

Signal-to-noise ratio: 90 dB

Wow and flutter: Immeasurable

Cassette deck

Frequency response

Normal (type I): 50 Hz — 14,000 Hz

CrO₂ (type II): 50 Hz — 14,000 Hz

Metal (type IV): 50 Hz — 14,000 Hz (only for playback)

Wow and flutter

0.15 % (WRMS)

General

Power requirement: AC 110 V/AC 127 V/AC 220 V/AC 230 V - AC 240 V \sim
(adjustable with the voltage selector),
50 Hz/60 Hz

Power consumption:

CA-MXJ300: 95 W (at operation)

8 W (on standby)

CA-MXJ200: 85 W (at operation)

9 W (on standby)

Maximum power consumption (for Taiwan only): 590 W

Dimensions (approx.): 265 mm x 315 mm x 361 mm (W/H/D)
(10⁷/₁₆ in. x 12⁷/₁₆ in. x 14¹/₄ in.)

Mass (approx.):

CA-MXJ300: 8.7 kg (19.2 lbs)

CA-MXJ200: 7.2 kg (15.9 lbs)

Supplied accessories

See page 8.

Speaker section

Type:

SP-MXJ300: 3-way bass-reflex type

SP-MXJ200: 2-way bass-reflex type

Speaker units:

SP-MXJ300: Woofer: 16 cm (6⁵/₁₆ in.) cone x1

Midrange: 4 cm (1⁵/₈ in.) cone x1

Tweeter: 2 cm (1³/₁₆ in.) piezo x1

SP-MXJ200: Woofer: 16 cm (6⁵/₁₆ in.) cone x1

Tweeter: 4 cm (1⁵/₈ in.) cone x1

Power handling capacity

SP-MXJ300: 100 W

SP-MXJ200: 60 W

Impedance:

6 Ω

Frequency range: 45 Hz — 22,000 Hz

Sound pressure level: 88 dB/w•m

Dimensions (approx.): 215 mm x 315 mm x 273 mm (W/H/D)

(8¹/₂ in. x 12⁷/₁₆ in. x 10³/₄ in.)

Mass (approx.): 3.5 kg (7.8 lbs) each

Mains (AC) Line Instruction (not applicable for Europe, U.S.A., Canada, Australia, and U.K.)

Instrucción sobre la línea de la red (CA) (no aplicable para Europa, EE.UU., Canadá, Australia, ni el Grã-Bretanha)

Instrução sobre a tensão da rede eléctrica (CA) (não aplicável para a Europa, os E.U.A., o Canadá, a Austrália e o Reino Unido)

主 (AC) 電源線路說明 (不適用於歐洲、美國、加拿大、澳洲及英國型號)

تعليمات خط التيار الكهربائي الرئيسي (المتردد) (لا تنطبق على أوروبا والولايات المتحدة الأمريكية وكندا وأستراليا والمملكة المتحدة)

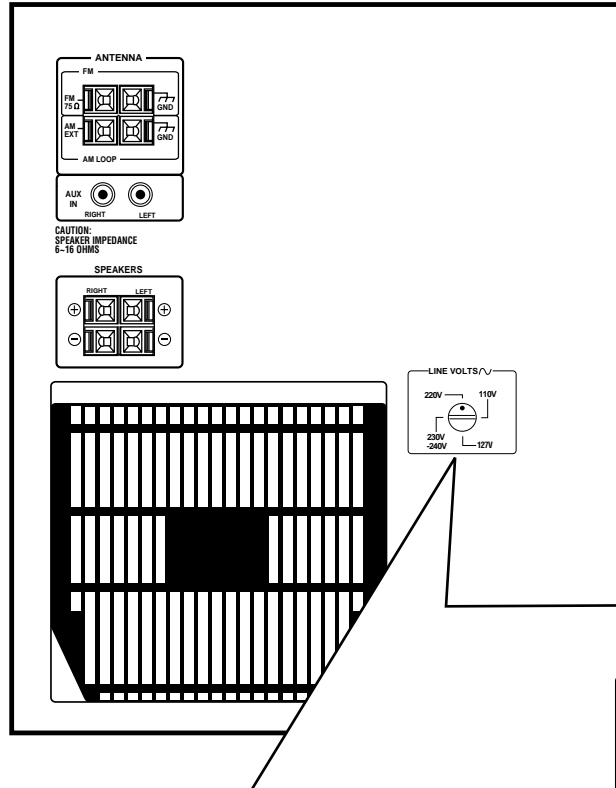

IMPORTANT for mains (AC) line

BEFORE PLUGGING IN, do check that your mains (AC) line voltage corresponds with the position of the voltage selector switch provided on the outside of this equipment and, if different, reset the voltage selector switch, to prevent from a damage or risk of fire/electric shock.

IMPORTANTE para la línea de la red (CA)

ANTES DE ENCHUFAR EL EQUIPO, compruebe si la tensión de la línea de la red (CA) corresponde con la posición del selector de tensión situado en la parte exterior del equipo, y si es diferente, reajuste el selector de tensión para evitar el riesgo de incendios/descargas eléctricas.

IMPORTANTE para a ligação à tensão da rede (CA)

ANTES DE LIGAR O APARELHO A UMA TOMADA DA REDE, verifique se a tensão da rede CA corresponde à posição do seletor de voltagem localizado na parte externa deste equipamento. Caso não corresponda, reajuste o seletor de voltagem a fim de evitar avarias ou riscos de incêndio e choque elétrico.

有關主 (AC) 電源線路的重要事項

接插電源以前，務請檢查當地的主 (AC) 電源線路電壓是否和位於本機外面的電壓選擇開關設定的位置一致。如果不一致，即重新設定電壓選擇開閉使符合當地電壓，以免損壞機器或引起火災／觸電的危險。

هام من اجل خط التيار الكهربائي الرئيسي (المتردد) قبل ادخال قابس الطاقة الكهربائية، تأكد من تطابق منتخب فولطية التيار الكهربائي الرئيسي (المتردد) الموجود على خلفية الجهاز مع فولطية التيار الكهربائي في بلدك. في حالة عدم التطابق، اعد ضبط مفتاح منتخب الفولطية على فولطية التيار الكهربائي المتردد في بلدك. عدم عمل ذلك، يمكن يؤدي الى حصول ضرر او حريق او صدمة كهربائية.